

personal Spaces

by md h



photo © Matteo Girola

EN Should personal spaces also be furnished? We, at Kristalia, think so. Personal Spaces by MD House is the project with which Kristalia embraces total living.

We are all looking for spaces to call our own, i.e. only what is precious and really belongs to us: our bedroom, our living room... Homes become places that we furnish painstakingly and slowly, piece by piece.

With an approach that has always been inspired by sustainability and optimisation, Kristalia enhances its offer by presenting the new Personal Spaces by MD House catalogue, proposing new ideas and configurations for contemporary spaces. These systems include tables and armchairs that interact with beds. Together now, for our homes and yours, and for community environments.

IT Anche lo spazio personale va arredato? Per noi di Kristalia sì. Personal Spaces by MD House è il progetto con cui Kristalia si apre al total living. Siamo tutti alla ricerca di spazi da chiamare nostri. Chiamiamo nostro solo ciò che ha valore e ci appartiene davvero: la nostra camera da letto, il nostro salotto... Le case diventano luoghi che arrediamo con riflessione e lentezza, arredo dopo arredo. Con un approccio che da sempre è guidato dalla sostenibilità ed ottimizzazione, Kristalia arricchisce la propria offerta presentando il nuovo catalogo Personal Spaces by MD House, proponendo nuove idee e configurazioni per spazi contemporanei. Sistemi che incontrano tavoli, poltrone che dialogano con letti. Da oggi insieme per le nostre e le vostre case e per ambienti collettivi.

DE Sollte auch der persönliche Raum bewusst eingerichtet werden? Wir von Kristalia sagen ja! Personal Spaces by MD House ist das Projekt, mit dem sich Kristalia dem umfassenden Wohnkonzept öffnet. Wir alle sind auf der Suche nach Räumen, die wir unser Eigen nennen können. Wir nennen aber nur das unser Eigen, was wertvoll ist und wirklich zu uns gehört: unser Schlafzimmer, unseren Wohnraum... Die Wohnungen und Häuser werden zu einem Ort, den wir mit Bedacht und Langsamkeit einrichten, Möbelstück für Möbelstück. Mit einem Ansatz, der seit jeher auf Nachhaltigkeit und Optimierung ausgerichtet ist, bereichert Kristalia sein Angebot durch die Präsentation des neuen Katalogs Personal Spaces by MD House, der viele neue Ideen und Gestaltungsvarianten für moderne Räume

enthält. Systeme, die auf Tische treffen, Sessel, die harmonisch mit Betten kommunizieren. Ab heute gemeinsam für unser und Ihr Zuhause sowie für Gemeinschaftseinrichtungen.

ES ¿Se decora también el espacio personal? En Kristalia pensamos que sí. Con el proyecto Personal Spaces by MD House, Kristalia se abre al total living. Todos buscamos espacios que podamos llamar nuestros. Solo llamamos nuestro lo que tiene un valor para nosotros, lo que nos pertenece de verdad: nuestro dormitorio, nuestro salón... Las casas se convierten en lugares que decoramos reflexionando lentamente, pieza a pieza. Con un enfoque que desde siempre se guía por la sostenibilidad y la optimización, Kristalia enriquece su oferta presentando el nuevo catálogo Personal Spaces by MD House, con nuevas ideas y configuraciones para los espacios contemporáneos. Sistemas que incorporan mesas, sillones que acompañan las camas. Juntos desde hoy, para nuestras y vuestras casas y para los ambientes colectivos.

FR Faut-il également meubler les espaces personnels? Pour nous de chez Kristalia, oui. Personal Spaces by MD House est le projet avec lequel Kristalia s'ouvre au Total Living. Nous sommes tous à la recherche d'espaces qui soient bien à nous. Nous disons qu'ils sont bien à nous uniquement quand ils ont de la valeur et qu'ils nous appartiennent vraiment: notre chambre à coucher, notre salon... Les habitations deviennent des lieux que nous aménageons de manière lente et réfléchie, en

ajoutant les meubles petit à petit. Avec une approche placée sous le signe de la durabilité et de l'optimisation, Kristalia enrichit son offre en présentant le nouveau catalogue Personal Spaces by MD House et en proposant de nouvelles idées et de nouveaux aménagements pour les espaces contemporains. Des systèmes qui s'unissent à des tables, des fauteuils qui dialoguent avec des lits. Désormais ensemble, pour nos maisons et les vôtres et pour les espaces collectifs.



A—Z index

Aria	76	Orbit	162
Avenue Boiserie	50	Tag	200
Avenue Boiserie Night	170	Telon	104
Avenue Cabinets	62	Valet	180
Avenue Library	22		
Avenue Night	156		
Avenue System	38		
Avenue—Up	12		
Bela	186		
Bombosoft	150		
Clapis	128		
Flap	194		
Legri	142		
Librio	204		
Novel	104		
Novel Island	166		

Day Storage Systems and Bookcases



Avenue Boiserie
50



Avenue Cabinets
62



Avenue Library
22

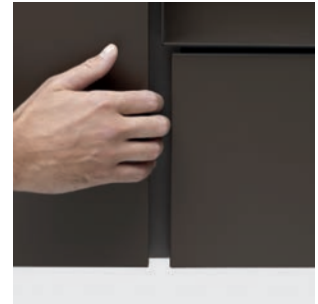

Avenue System
38



Avenue—Up
12

Wardrobes and Walk-in closets



Aria
76



Novel
104

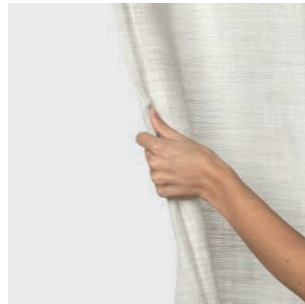

Telon
104

Beds and Night Storage Systems

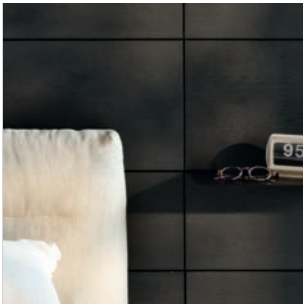

Avenue Boiserie
170



Avenue Night
156



Bombosoft
150



Clapis
128



Legri
142



Novel Island
166



Orbit
162

Accessories

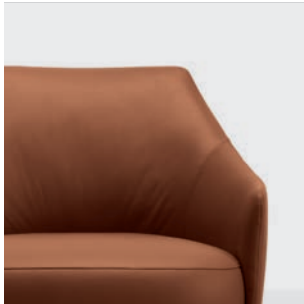

Bela
186



Flap
194



Librio
204



Tag
200



Valet
180



Avenue Boiserie	50
Avenue Cabinets	62
Avenue Library	22
Avenue System	38
Avenue—Up	12



Avenue—Up shelving system
Wood, Lacquered metal

Avenue—Up





1



2

Avenue—Up



1



2

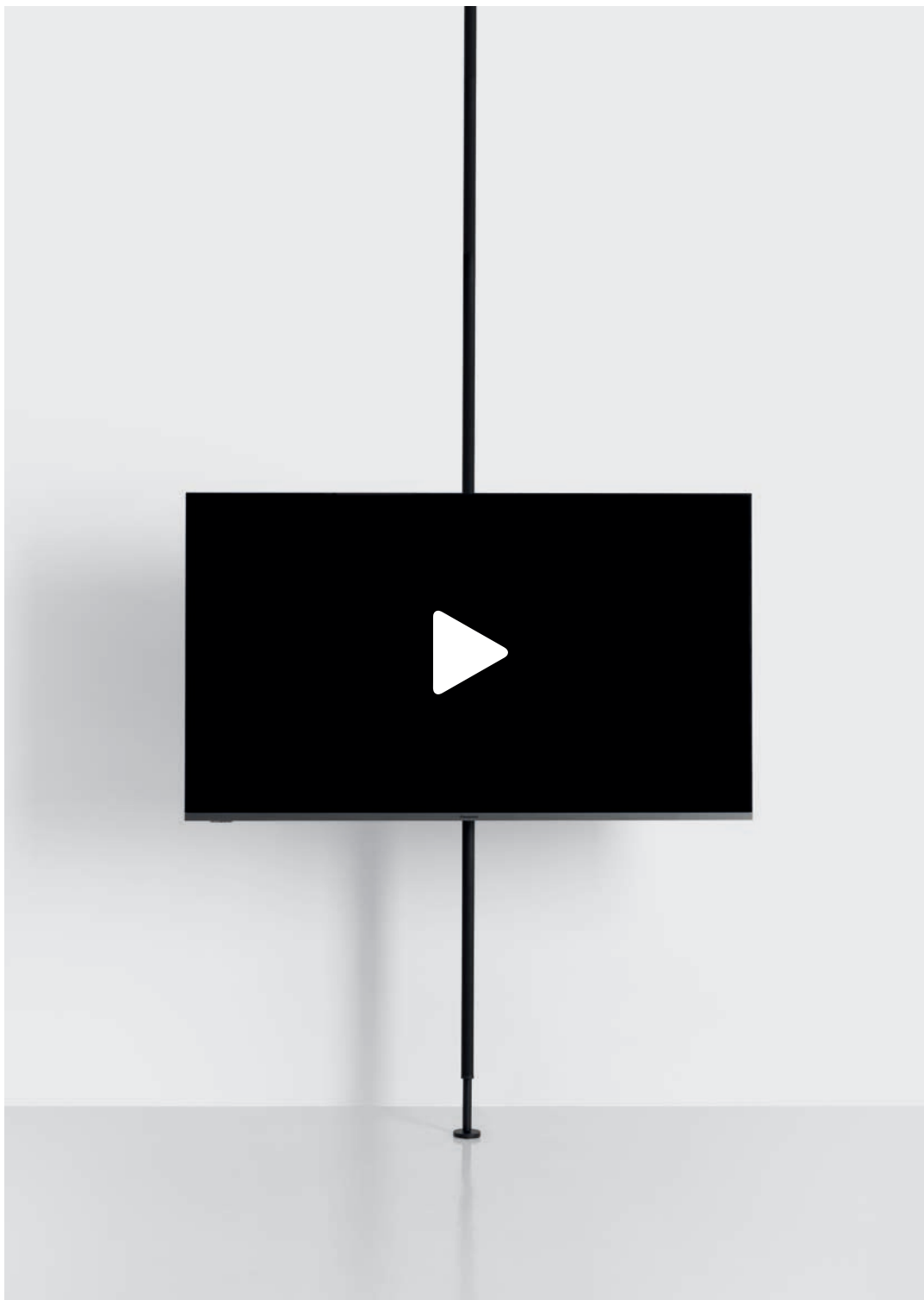

Avenue—Up TV swivel mechanism
Lacquered metal





1



Cable passage cover



Avenue—Up TV swivel mechanism
Lacquered metal



Ceiling support



Wall support



Adjustable feet



4

Floor to Ceiling support

Max H 350 cm H 137⁵/₈"

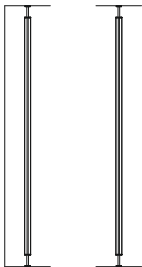

Floor to wall support

H 236,8 cm H 93²/₈"
H 256 cm H 100⁶/₈"



5

Shelf/unit support

	45	60	90	120
	17 ⁵ / ₈ "	23 ⁵ / ₈ "	35 ³ / ₈ "	47 ² / ₈ "
2,5 1"	_____			

Shelf P 35 cm D 13⁵/₈"

	45	60	90	120
	17 ⁵ / ₈ "	23 ⁵ / ₈ "	35 ³ / ₈ "	47 ² / ₈ "
1,2 4 ⁸ / ₈ "	_____			

Type

Single sided



Double sided

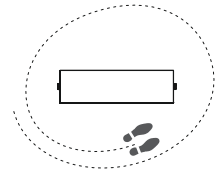

Swivel mirror



L 60 H 160 cm
W 23⁵/₈" H 63"

TV swivel mechanism

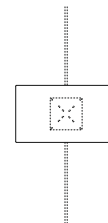

Avenue – Up

DESIGN BY RUGA.PERISSINOTTO & SCIUTO ARCHITETTI, 2022

▣ Avenue-Up è un sistema a montanti verticali con cui realizzare composizioni a parete o a centro stanza. Caratteristica dei montanti, in estruso di alluminio anodizzato Nero o Bronzo, è la sezione curva. Una forma che li rende visivamente morbidi, ulteriormente alleggerita all'altezza di piedi e spintori regolabili. Ai montanti si abbinano basi e pensili del sistema Avenue System, mensole in legno, vassoi in alluminio e vetro con luce integrata, elementi a giorno. Il montante può essere usato come supporto per lo specchio o per la TV, anche da solo, installato a parete o a soffitto. Inoltre, può integrare una luce a LED verticale e il sistema di cablaggio per la TV.

▣ Avenue-Up is a vertical upright system that can be used to create wall systems or systems in the middle of a room. The uprights, made of Black or Bronze extruded anodized aluminium, feature a rounded cross-section. This shape gives them a smooth appearance, made lighter at the foot height with adjustable pushers. The uprights can be combined with base and wall units in the Avenue System, wooden shelves, aluminium and glass trays with integrated light, and open elements. The upright can be used as a mirror or TV stand, even on its own, or wall- or ceiling-mounted. It can also incorporate a vertical LED light and a TV cabling system.

▣ Avenue-Up ist ein aus senkrechten Pfosten bestehendes System, mit dem Zusammenstellungen an der Wand oder in der

Raummitte realisiert werden können. Das Hauptmerkmal der aus eloxiertem Pressgussaluminium in den Farben Schwarz und Bronze bestehenden Pfosten ist ihr abgerundeter Querschnitt. Eine Form, die ihnen eine weichere Optik schenkt und in der Höhe der verstellbaren Füße und der Spannschrauben noch leichter wirkt. Die Pfosten werden mit Unterschränken und Oberschränken des Systems Avenue System, Regalböden aus Holz, Tabletteinsätzen aus Aluminium und Glas mit integrierter Beleuchtung sowie offenen Elementen kombiniert. Der Pfosten kann auch alleine an der Wand oder an der Decke montiert und als Träger für einen Spiegel oder das TV-Gerät genutzt werden. Außerdem lassen sich eine senkrechte LED-Beleuchtung und ein Verkabelungssystem für das TV-Gerät integrieren.

▣ Avenue-Up es un sistema de montantes verticales que permite realizar composiciones de pared o en el centro de la habitación. Realizados en aluminio anodizado extruido Negro o Bronce, los montantes se distinguen por su sección curva. Una forma que produce un delicado efecto visual, cuya ligereza es resaltada a la altura de las patas con empujadores regulables. Los montantes se combinan con muebles bajos y colgantes del sistema Avenue System, bandejas de aluminio y cristal con luz integrada y elementos abiertos. El montante puede utilizarse como soporte para el espejo o para la televisión, incluso solo, instalándolo en la pared o en el techo. También puede incorporar una luz LED

vertical y el sistema de cableado para la televisión.

▣ Avenue-Up est un système de montants verticaux avec lequel il est possible de réaliser des compositions que l'on pourra agencer contre un mur ou au milieu d'une pièce. La caractéristique des montants en aluminium extrudé anodisé Noir ou Bronze est sa section arrondie. Une forme qui en adoucit l'aspect visuel et qui est encore allégée au niveau des pieds et des vérins réglables. Il est possible d'associer à ces montants, des éléments bas et des éléments hauts du système Avenue System, des étagères en bois, des étagères à rebords en aluminium et en verre avec éclairage intégré et des éléments ouverts. Le montant peut faire office de support pour le miroir ou pour la TV - et être également utilisé comme élément unique - et peut se fixer soit au mur soit au plafond. En outre, il peut loger un éclairage à leds vertical ainsi que le système de câblage pour la TV.

Units single/double sided P 35 cm D 13⁵/₈"

	45 17 ⁵ / ₈ "	60 23 ⁵ / ₈ "	90 35 ³ / ₈ "	120 47 ² / ₈ "
24 9 ⁴ / ₈ "				
32 12 ⁵ / ₈ "				
48 18 ⁷ / ₈ "				
64 25 ² / ₈ "				

Units single/double sided, open 1 side P 35 cm D 13⁵/₈"

	45 17 ⁵ / ₈ "	60 23 ⁵ / ₈ "	90 35 ³ / ₈ "	120 47 ² / ₈ "
24 9 ⁴ / ₈ "				
32 12 ⁵ / ₈ "				

Units double sided, open 2 sides P 35 cm D 13⁵/₈"

	45 17 ⁵ / ₈ "	60 23 ⁵ / ₈ "	90 35 ³ / ₈ "	120 47 ² / ₈ "
24 9 ⁴ / ₈ "				
32 12 ⁵ / ₈ "				

TV back panel

	90 35 ³ / ₈ "	120 47 ² / ₈ "
96 37 ⁶ / ₈ "		
124 48 ⁷ / ₈ "		



Elements with a 45° edge



Avenue Library
Lacquered metal

Avenue System
Wood

Telon curtain
Zulu 2 fabric

Avenue Library







Avenue Library
Lacquered metal

Avenue System
Wood



Avenue Library
Lacquered metal



1



2



Avenue Library
Lacquered metal

Avenue System
Wood

Telon curtain
Zulu 2 fabric



Tag occasional table
Laminate top



Avenue Library
Lacquered metal

Avenue System
Wood



1



2

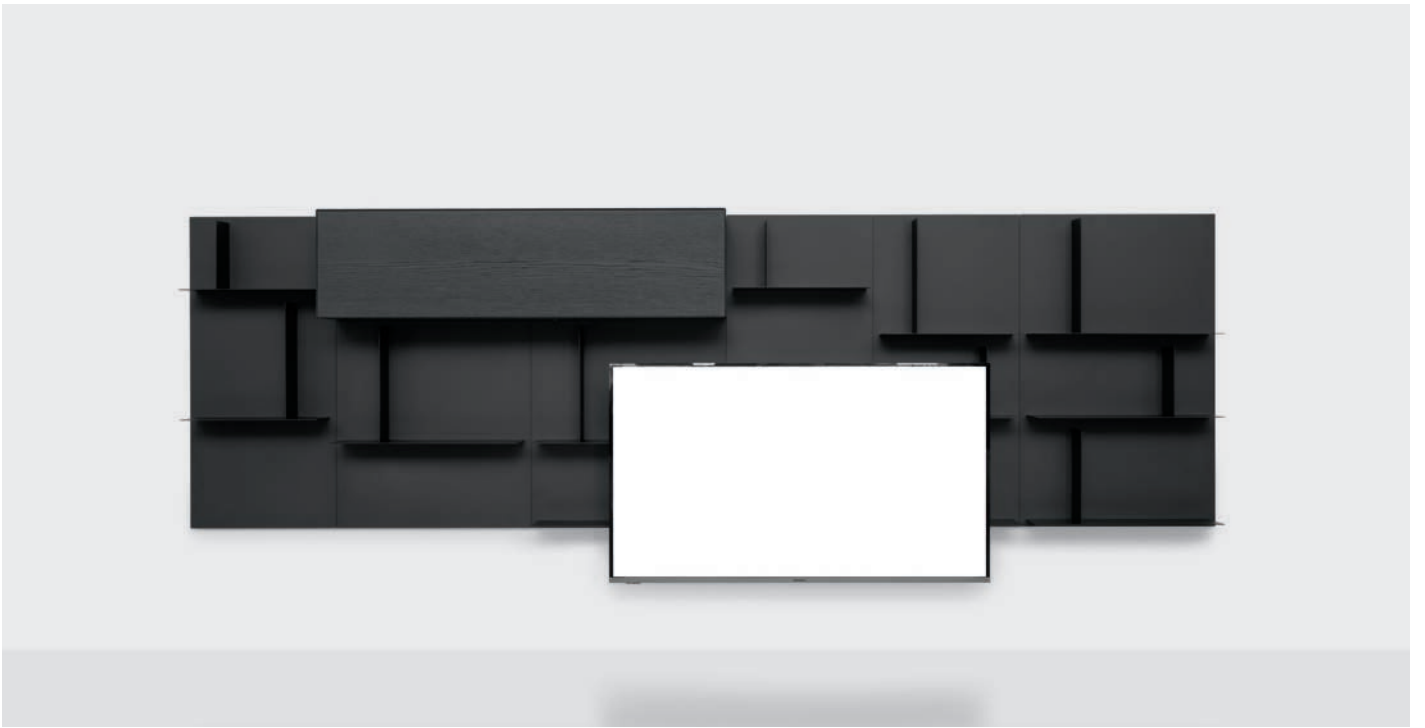

Avenue Library + Avenue System



2



Swivel and extendable TV support

□ I pannelli porta TV sono al contempo essenziali e funzionali. Due i sistemi disponibili: il primo è generoso nelle dimensioni e caratterizzato da un supporto fisso. Il secondo ha invece dimensioni ridotte e consiste in un braccio telescopico nascosto che permette di orientare lo schermo in base alle esigenze, facendolo sembrare quasi sospeso davanti alle mensole. Per entrambi i sistemi il cablaggio avviene nel retro dei pannelli, leggermente staccati dalla parete.

EN **TV panels are both minimalist and functional. Two systems are available: one is generous in dimensions and features a fixed support. The other, is smaller in dimensions and consists of a concealed telescopic arm, which allows the screen to be adjusted as required, making it appear almost suspended in front of the shelves. Both systems have wiring in the back of the panels, which are slightly detached from the wall.**

DE TV-Wandpaneele sind ebenso essenziell wie zweckmäßig. Es stehen zwei Systeme zur Wahl: Das erste ist großzügig bemessen und zeichnet sich durch eine fixe Halterung aus. Das zweite System hat geringe Abmessungen und besteht aus einem versteckten Teleskoparm, mit dem der Bildschirm je nach Bedarf ausgerichtet werden kann, so dass er fast vor den Regalböden zu schweben scheint. Bei beiden Systemen erfolgt die Verkabelung auf der Rückseite der leicht von der Wand abstehenden Paneele.

ES Los paneles para TV son esenciales y funcionales al mismo tiempo. Hay dos sistemas disponibles: el primero, de grandes dimensiones, se caracteriza por su soporte fijo. El segundo tiene un tamaño reducido y consiste en un brazo telescópico oculto que permite orientar la pantalla en función de las necesidades, haciendo que parezca casi suspendida delante de los estantes. En ambos sistemas el cableado se efectúa en la parte trasera de los paneles, ligeramente separados de la pared.

FR Les panneaux TV sont à la fois épurés et fonctionnels. Deux systèmes disponibles: le premier a de grandes dimensions et est caractérisé par un support fixe. Le second, en revanche, a de petites dimensions et est doté d'un bras télescopique masqué permettant d'orienter l'écran en fonction des besoins, le faisant paraître presque suspendu devant les étagères. Pour les deux systèmes, le câblage s'effectue au dos des panneaux qui sont légèrement écartés du mur.



1

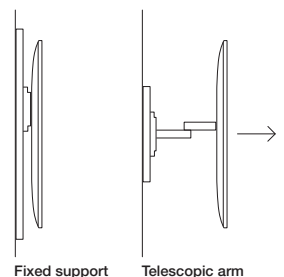

Fixed support

Telescopic arm



Bianco



Grigio sabbia



Conchiglia



Terracotta



Grigio alluminio



Grigio Londra

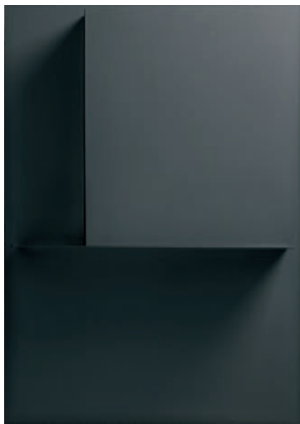

Grigio antracite



Nero



Verde oliva

□ I pannelli in metallo di Avenue Library sono verniciati a polveri nei colori Exclusive o Goffrati. I colori Exclusive sono più neutri e caratterizzati da una finitura opaca: merito di un protettivo super-opaco, frutto della ricerca del centro di verniciatura a polveri interno. I colori Goffrati presentano invece tonalità più accese. In entrambi i casi, la verniciatura a polveri garantisce forte resistenza e lunga durata.

EN Avenue Library metal panels are powder-coated in Exclusive or Embossed colours. The Exclusive colours are more neutral and have a matt finish: this is obtained with a super-matt protective coating, the result of research by the in-house powder-coating centre. Embossed colours, instead, come in brighter colours. In both cases, powder coating guarantees high resistance and a long life.

□ Die Platten aus Metall von Avenue Library haben eine Pulverbeschichtung in den Farben Exclusive oder Strukturlack. Die Farben Exclusive sind neutraler und zeichnen sich durch eine matte Oberfläche mit supermatter Schutzschicht aus, die das Ergebnis der Forschung des internen Pulverbeschichtungszentrums ist. Die Farben der Strukturlackausführung zeigen sich hingegen mit kräftigeren Tönen. In beiden Fällen garantiert die Pulverbeschichtung hohe Widerstandsfähigkeit und lange Lebensdauer.

□ Los paneles de metal de Avenue Library están barnizados con polvo en los colores Exclusive o Gofrados. Los colores Exclusive son más neutros y se distinguen por su acabado mate, mérito de un protector supermate desarrollado por la investigación del centro interno de barnizado en polvo. Los colores Gofrados presentan tonalidades más fuertes. En ambos casos, el barnizado con polvo garantiza una alta resistencia y una larga duración.

□ Les panneaux en métal d'Avenue Library sont laqués poudre dans les coloris Exclusive ou Gaufrés. Les coloris Exclusive sont plus neutres et sont caractérisés par une finition mate grâce à un protecteur super-mat, fruit de la recherche du centre de thermolaquage interne. Les coloris Gaufrés ont, en revanche, des tonalités plus vives. Dans les deux cas, le thermolaquage assure une forte résistance et une longue durée.



Exclusive Champagne

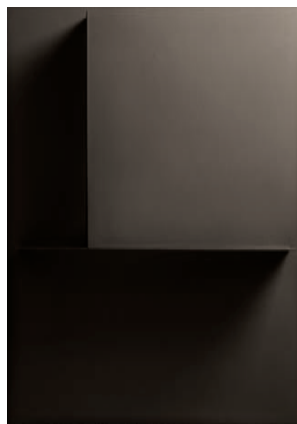

Exclusive Brown

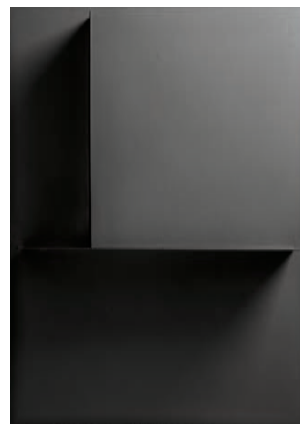

Exclusive Space Gray



Exclusive Onyx Black



1



Avenue Library + Avenue System

Avenue Library

DESIGN BY RUGA.PERISSINOTTO & SCIUTO ARCHITETTI, 2021

▣ Libreria essenziale dal forte impatto scenico, Avenue Library è caratterizzata da linee sottili, design modulare e infinite possibilità di personalizzazione. La libreria si progetta a piacere in base agli spazi disponibili e alle esigenze, dalla composizione più piccola a quella a tutta parete. Non solo è possibile combinare tra loro moduli di diverse dimensioni, anche con luce perimetrale opzionale, ma anche integrare pensili e basi Avenue System e pannelli TV. La libreria è in metallo, un materiale contemporaneo e sostenibile perché 100% riciclabile, verniciato a polveri nelle finiture Exclusive o Goffrate.

▣ **A minimalist bookcase with a striking visual impact, Avenue Library features slender lines, a modular design and countless options for customisation. The bookcase can be designed as required according to the available space and needs, from the smallest to the full-wall composition. Not only can you combine units of different dimensions, including optional perimeter lights, but also incorporate Avenue System wall and base units, and TV panels. The bookcase is made of metal, a contemporary and sustainable material that is 100% recyclable, which is powder-coated in Exclusive or Embossed finishes.**

▣ Avenue Library ist ein essenzielles Bücherregal mit starker visueller Wirkung. Es zeichnet sich durch schlanke Linien, ein modulares Design und unzählige individuelle

Gestaltungsmöglichkeiten aus. Das Bücherregal lässt sich je nach Raumangebot und Anforderungen ganz nach Belieben planen, von der kleinsten bis zur wandfüllenden Zusammenstellung. Dabei können nicht nur Module mit verschiedenen Größen und eventueller umlaufender Beleuchtung miteinander kombiniert, sondern auch die Wand- und Unterschränke Avenue System und TV-Wandpaneele eingefügt werden. Das Bücherregal besteht aus Metall, einem zu 100% recycelbaren und daher zeitgemäßen und nachhaltigen Material und besitzt eine Pulverlackierung in den Farben Exclusive oder Strukturlack.

▣ **Esencial y de fuerte impacto escénico, Avenue Library se caracteriza por sus líneas finas, su diseño modular y sus infinitas posibilidades de personalización. El proyecto de la librería se realiza libremente en función del espacio disponible y de las propias necesidades: de la composición más pequeña a la que cubre toda la pared. Además de poder combinar módulos de distintas dimensiones, incluso con luz perimétrica opcional, es posible integrar colgantes y muebles bajos Avenue System y paneles para TV. La librería es de metal, un material contemporáneo y sostenible por ser 100% reciclable, pintado con polvo en los acabados Exclusive o Gofrados.**

▣ **Bibliothèque épurée au fort impact visuel, Avenue Library se distingue par des lignes fines,**

un design modulaire et des possibilités de personnalisation infinies. La bibliothèque se compose selon les espaces à disposition et les besoins, allant de la composition la plus petite jusqu'à couvrir tout un mur. Il est possible non seulement d'associer des modules de différentes dimensions, avec éclairage périphérique optionnel, mais également d'ajouter des éléments hauts et bas Avenue System et des panneaux TV. La bibliothèque est réalisée en métal - un matériau contemporain et durable puisqu'il est 100% recyclable - laqué poudre dans les finitions Exclusive et Gauffrées.

Sizes

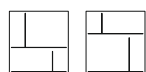

L 45 P 23 H 64 cm
W 17^{5/8}" D 9" H 25^{2/8}"

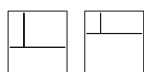

L 45 P 23 H 64 cm
W 17^{5/8}" D 9" H 25^{2/8}"

L 60 P 23 H 64 cm
W 23^{5/8}" D 9" H 25^{2/8}"

L 60 P 23 H 64 cm
W 23^{5/8}" D 9" H 25^{2/8}"

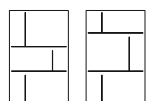

L 45 P 23 H 96 cm
W 17^{5/8}" D 9" H 37^{5/8}"

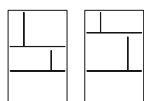

L 45 P 23 H 96 cm
W 17^{5/8}" D 9" H 37^{5/8}"

L 60 P 23 H 96 cm
W 23^{5/8}" D 9" H 37^{5/8}"

L 60 P 23 H 96 cm
W 23^{5/8}" D 9" H 37^{5/8}"



TV panel
L 45 P 4,8 H 32 cm
W 17^{5/8}" D 1^{7/8}" H 12^{5/8}"

L 60 P 4,8 H 32 cm
W 23^{5/8}" D 1^{7/8}" H 12^{5/8}"

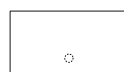

TV panel
L 90 P 4,8 H 64 cm
W 35^{3/8}" D 1^{7/8}" H 25^{2/8}"

L 120 P 4,8 H 64 cm
W 47^{2/8}" D 1^{7/8}" H 25^{2/8}"

L 150 P 4,8 H 64 cm
W 59" D 1^{7/8}" H 25^{2/8}"

L 180 P 4,8 H 64 cm
W 70^{7/8}" D 1^{7/8}" H 25^{2/8}"



TV panel
L 90 P 4,8 H 96 cm
W 35^{3/8}" D 1^{7/8}" H 37^{5/8}"

L 120 P 4,8 H 96 cm
W 47^{2/8}" D 1^{7/8}" H 37^{5/8}"

L 150 P 4,8 H 96 cm
W 59" D 1^{7/8}" H 37^{5/8}"

L 180 P 4,8 H 96 cm
W 70^{7/8}" D 1^{7/8}" H 37^{5/8}"



Avenue System
Wood, Matt lacquer, Lacquered metal

Avenue Boiserie
Matt lacquer, Lacquered metal

Telon curtain
Twilight fabric

Avenue System





Avenue System
Wood, Matt lacquer, Lacquered metal

▣ Nel sistema Avenue i vani a giorno si integrano ai pensili chiusi, rendendo le composizioni più leggere. Sono di due tipi: contenitori con profili a 45°, laccati o in essenza, e contenitori in metallo, caratterizzati dagli spessori ridottissimi e dal fissaggio laterale magnetico. I contenitori in metallo sono disponibili nelle finiture Exclusive e Goffrate, anche con schiena in finitura diversa, attrezzabile con illuminazione a LED. I vani a giorno hanno diverse dimensioni e sono progettati per combinarsi a tutti gli altri elementi del sistema Avenue.

EN The Avenue system features open wall units combined with closed wall units, making compositions lighter. Two types are available: storage units with 45° profiles, with a lacquered or wood veneer finish, and metal storage units, which feature very narrow thicknesses and magnetic fastening at the side. The metal storage units are available in Exclusive and Embossed finishes, with an optional different finish for the back panel, which can be fitted with LED lighting. The open wall units come in different dimensions and are designed to be combined with all the other elements in the Avenue system.

▣ Im System Avenue fügen sich offene Abteile zwischen geschlossene Oberschränke ein und machen die Zusammenstellungen leicht und schwerelos. Es gibt zwei Typen: Fächer mit 45°-Profilen, lackiert oder aus Holz, und Fächer aus Metall, die sich durch ganz geringe Stärken

und eine seitliche Magnetbefestigung auszeichnen. Die Fächer aus Metall sind in den Oberflächenausführungen Exclusive und Strukturlack erhältlich, auch mit Rückwand in anderer Farbe und möglicher LED-Beleuchtung. Die offenen Abteile haben verschiedene Größen und sind so konzipiert, dass sie mit allen weiteren Elementen des Systems Avenue kombiniert werden können.

▣ En el sistema Avenue los compartimentos abiertos se integran con los colgantes cerrados aportando ligereza a las composiciones. Son de dos tipos: contenedores con perfiles angulares de 45°, lacados o de madera, y contenedores de metal, caracterizados por sus reducidísimos espesores y por su fijación lateral magnética. Los contenedores de metal están disponibles en los acabados Exclusive y Gofrados y la trasera, equipable con iluminación LED, puede realizarse en un acabado diferente. Los compartimentos abiertos tienen distintos tamaños y han sido diseñados para combinarlos con todos los elementos del sistema Avenue.

▣ Dans le système Avenue, les éléments ouverts s'intègrent au milieu des éléments hauts fermés par des portes afin d'alléger les compositions. Ils existent en deux versions: caissons avec chants avant à 45°, laqués ou en bois, et caissons en métal se distinguant par des épaisseurs très fines et par une fixation latérale magnétique. Les caissons en métal existent dans les finitions Exclusive et Gauffrées. Ils peuvent aussi avoir le

fond décliné dans une autre finition et être équipés d'un éclairage à leds. Les éléments ouverts ont plusieurs dimensions au choix et ont été conçus afin de pouvoir s'associer à tous les autres éléments du système Avenue.



Open unit with 45° profiles



Metal open unit

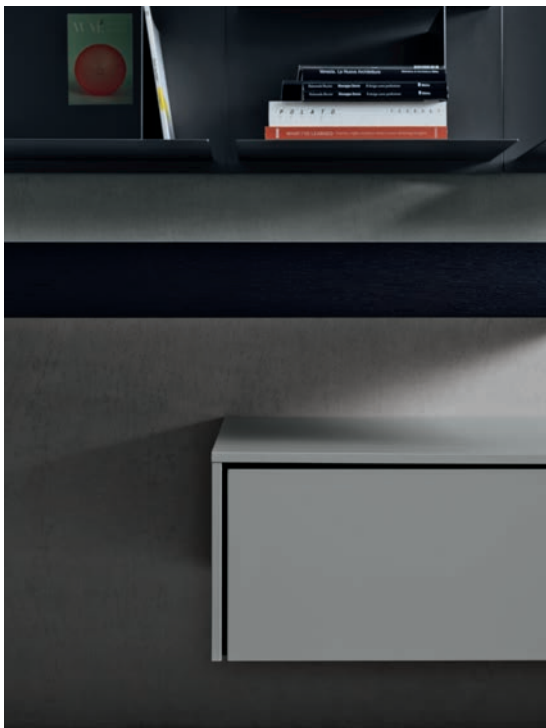

1



GOLA base



3



Avenue System
Wood, Matt lacquer

Avenue Library
Lacquered metal

Librio occasional table
Laminate top



PROFILO base



▣ Profilo perimetrale in metallo verniciato Exclusive, maniglia a filo in alluminio e pannello in Specchio Satinato o in Laminam caratterizzano le Basi Profilo. Nella versione in Laminam, un materiale ceramico con proprietà antibatteriche composto per il 94% da materiali di origine naturale e per il 40% da materiale riciclato, il pannello è disponibile nelle tre finiture Emperador Extra, Nero Greco e Statuarietto, che richiamano le venature del marmo.

EN **The distinctive features of Profilo base units are the Exclusive painted metal perimeter profile, flush aluminium handle and Satinated Mirror or Laminam panel. For the version in Laminam, a ceramic material with antibacterial properties made of 94% natural materials, and 40% recycled materials, the panel is available in three finishes: Emperador Extra, Nero Greco and Statuarietto, which recall the veining of marble.**

DE Umrandungsprofil aus lackiertem Metall Exclusive, kantengleicher Griff aus Aluminium und Platte aus satiniertem Spiegelglas oder Laminam sind das Erkennungszeichen der Unterschränke Profilo. Bei der Version aus Laminam, ein keramisches Material mit antibakteriellen Eigenschaften, das zu 94% aus Materialien natürlichen Ursprung und zu 40% aus recycelten Materialien besteht, ist die Platte in den drei Ausführungen Emperador Extra, Nero Greco und Statuarietto erhältlich, die an die Aderung von Marmor erinnern.

ES Los muebles bajos Profilo se caracterizan por su perfil perimétrico de metal barnizado Exclusive, su tirador enrasado de aluminio y su panel de Espejo satinado o Laminam. En la versión de Laminam, material cerámico con propiedades antibacterianas que incluye un 94% de materiales de origen natural y un 40% de material reciclado en su composición, el panel está disponible en tres acabados, Emperador Extra, Nero Greco y Statuarietto, que evocan los veteados del mármol.

FR Le profil sur le pourtour en métal laqué Exclusive, la poignée affleurante en aluminium et le panneau central en Miroir Satiné ou en Laminam caractérisent les éléments bas Profilo. Dans la version Laminam, un matériau céramique avec propriétés antibactériennes se composant de 94% de matières d'origine naturelle et de 40% de matières recyclées, le panneau central existe dans les trois finitions Emperador Extra, Nero Greco et Statuarietto, qui rappellent les veines du marbre.



Easy to clean and maintain



Emperador Extra Laminam



Statuarietto Laminam



Nero Greco Laminam



Wall units with a 45° edge



2



3



Avenue System + Avenue Boiserie



GOLA base



3



GOLA base



PROFILO base



SIMPLE base

Free-standing base units, on base support and suspended **P 50 cm D 19⁵/₈"**

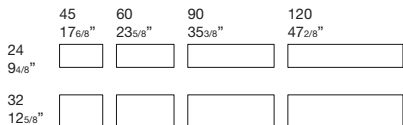

Metal base supports **P 42 cm D 16⁴/₈"**

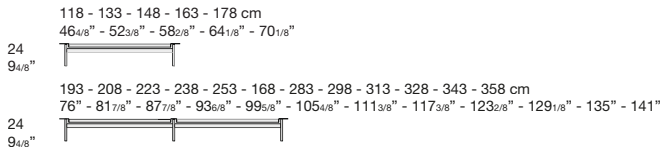

Metal trays **P 50 cm D 19⁵/₈"**

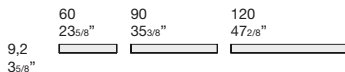

Wall units **P 35 cm D 13⁶/₈"**

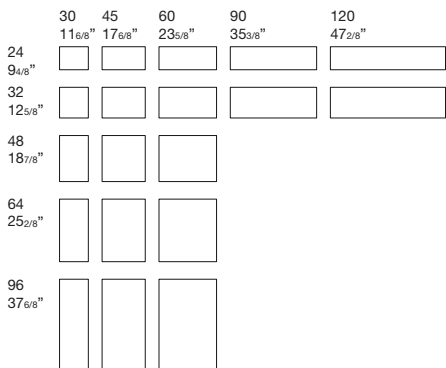

Top for base units **P 50 cm D 19⁵/₈"**

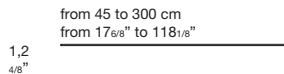

Top for base units/Folder edge shelf **P 50 cm D 19⁵/₈"**

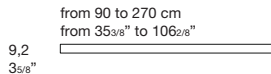

Wall units, 1 open side **P 35 cm D 13⁶/₈"**

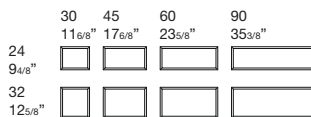

Metal wall units, 1 open side **P 35 cm D 13⁶/₈"**



Avenue System

DESIGN BY RUGA.PERISSINOTTO & SCIUTO ARCHITETTI, 2021

▣ Avenue è un sistema modulare per il living contemporaneo, una soluzione dal design multifunzionale da comporre in base alle caratteristiche dello spazio e alle esigenze del momento. Basi e pensili si affiancano tra loro per creare composizioni a terra, su basamento o sospese. Sono disponibili in diverse dimensioni e con tre sistemi di apertura: gola, profilo e simple per le basi, push-pull per i pensili con costruzione a 45°. La selezione di materiali consente di personalizzare l'arredo in base al proprio gusto, scegliendo tra il calore del legno o l'eleganza dello specchio acidato, la morbidezza del laccato o il tocco innovativo delle ceramiche.

EN **Avenue is a modular system for contemporary living, a multifunctional design solution that can be arranged according to the type of space and current needs. Base and wall units can be placed side by side to create floor-standing, base support or suspended compositions. They are available in various dimensions and with a choice of 3 opening systems: Gola, Profilo and Simple for base units, push-pull for wall units with a 45° edge. The selection of materials allows furniture to be customised according to tastes, choosing the warm appeal of wood or the elegant etched mirror, the softness of lacquer or the innovative touch of ceramic tiles.**

DE Avenue ist ein Modulsystem für zeitgemäßes Wohnen, eine multifunktionelle Designlösung,

die sich je nach den Merkmalen des Raums und den Bedürfnissen des Augenblicks zusammenstellen lässt. Unter- und Oberschränke werden aneinandergereiht, um bodenstehende, hängende oder auf einem Grundgestell ruhende Zusammenstellungen zu kreieren. Sie sind in verschiedenen Größen und mit drei Öffnungssystemen erhältlich: Hohlkehle, Profil und Simple für die Unterschränke, Push-Pull für die Oberschränke mit 45°-Konstruktion. Das Materialangebot ermöglicht eine individuelle Gestaltung der Möbel, da Sie zwischen der Wärme von Holz oder der Eleganz von geätztem Spiegelglas, der Weichheit der Lackierung oder dem innovativen Touch von Keramik wählen können.

ES Avenue es un sistema modular para el salón contemporáneo, una solución de diseño multifuncional que permite crear distintas composiciones en función de las características del espacio y de las necesidades del momento. Los muebles bajos y los colgantes se unen entre sí para formar composiciones de suelo, sobre una base o suspendidas. Están disponibles en distintos tamaños y con tres sistemas de apertura: gola, perfil y simple para los muebles bajos y push-pull para los colgantes con perfil angular de 45°. La gama de materiales permite personalizar el mobiliario en función del gusto personal eligiendo entre el calor de la madera y la elegancia del espejo tratado al ácido, entre la suavidad del lacado y el tacto innovador de las cerámicas.

FR Avenue est un système modulaire pour le living contemporain, une solution au design multifonctionnel que l'on pourra composer en fonction des caractéristiques de l'espace à aménager et des besoins du moment. Les éléments bas et hauts s'unissent pour créer des compositions au sol, sur piétement ou suspendues. Ils existent en différentes dimensions au choix et avec trois systèmes d'ouverture: Gola, Profilo et Simple pour les éléments bas; push-pull pour les éléments hauts avec assemblage à 45°. La sélection des matériaux permet de personnaliser les meubles en fonction des goûts de chacun, en choisissant entre la chaleur du bois et l'élégance du miroir dépoli ou bien entre la douceur de la finition laquée et la touche innovante des céramiques.

Base units
P 50 cm D 19^{5/8}"



Bases opening



Wall units
P 35 cm D 13^{5/8}"



Wall units opening



Wall units with a 45° edge



Avenue Boiserie
Hallingdal 65 fabric, Mirror, Cork, Lacquered metal

Avenue Boiserie



1



2



Avenue Boiserie
Hallingdal 65 fabric, Mirror, Cork, Lacquered metal

Bela armchair
Upholstered in Elmosoft leather



Avenue Boiserie
Matt lacquer, Cork, Wood, Lacquered metal

Avenue System
Wood, Lacquered metal



1



2

□ Per creare uno spazio di lavoro compatto e funzionale bastano pochi elementi. Dalla combinazione tra mensolone, base sospesa con elemento vassoio, boiserie con illuminazione, mensole, vano a giorno e pannello in sughero si ottiene un ufficio con tutto il necessario per lavorare da remoto o trovare il proprio spazio di concentrazione. E se il mensolone, dotato di caricabatterie USB e a induzione, si usa come scrittoio, basi sospese, mensole e vani a giorno accolgono generosamente libri, documenti e accessori, mentre i pannelli della boiserie diventano pratiche moodboard.

EN **Only a few elements are needed to create a compact and functional workspace. By combining a large shelf, a suspended base unit with a tray element, a boiserie with lighting, shelves, an open compartment and a cork panel, you can create an office with everything you need to work remotely or find your own space in which to concentrate. And if the large shelf, fitted with USB and induction chargers, is used as a writing desk, suspended base units, shelves and open wall units generously house books, documents and accessories, whereas boiserie panels become practical mood boards.**

DE Es genügen wenige Elemente, um einen kompakten und funktionellen Arbeitsbereich zu schaffen. Die Kombination aus Bord, Hänge-Unterschrank mit Tabletteinsatz, Boiserie mit Beleuchtung, Regalböden, offenem Abteil

und Korkplatte ergibt ein Büro mit allem, was man braucht, um von zu Hause aus zu arbeiten oder einen Ort zum Konzentrieren einzurichten. Und wenn man das mit USB- und Induktionsladegeräten ausgestattete extrastarke Bord als Schreibtisch nutzt, bieten Unterschränke, Regalböden und offene Abteile großzügig Platz für Bücher, Unterlagen und Accessoires, während die Wandverkleidungsplatten zu praktischen Moodboards werden.

ES Para crear un espacio de trabajo compacto y funcional bastan pocos elementos. Con un estante grande, un mueble bajo suspendido con elemento bandeja, una boiserie con iluminación, algunos estantes, un compartimiento abierto y un panel de corcho se obtiene una oficina con todo lo necesario para trabajar a distancia o para disfrutar de un lugar personal donde concentrarse. El estante grande, dotado de cargador USB y por inducción, se utiliza como escritorio, mientras que los muebles bajos suspendidos, los estantes y los compartimentos abiertos acogen generosamente los libros, los documentos y los accesorios y los paneles de la boiserie se transforman en prácticos moodboards.

FR Pour créer un espace de travail compact et fonctionnel, quelques éléments suffisent. En combinant une étagère épaisse, un élément bas suspendu avec plateau à rebords, un habillage mural avec éclairage, des étagères, un élément

ouvert et un panneau en liège, on obtient un bureau avec tout le nécessaire pour travailler à distance ou bien un espace pour se concentrer. Et si l'on utilise l'étagère épaisse dotée de chargeur USB et à induction comme bureau, les étagères et les éléments ouverts pourront loger des livres, des documents et des accessoires alors que les panneaux de l'habillage mural pourront devenir de pratiques moodboards.

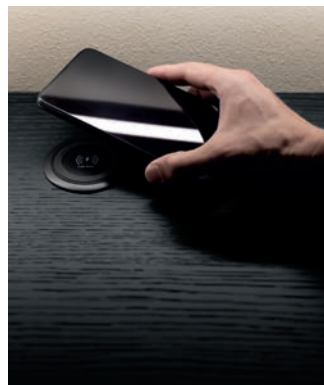
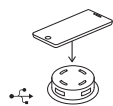

Induction chargers

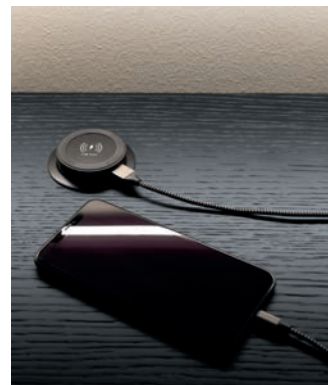

USB



Avenue Boiserie
Remix 3 fabric, Matt lacquer, Wood, Lacquered metal







1

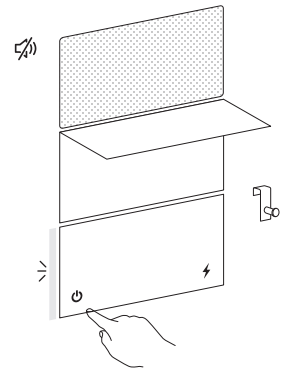

Hook

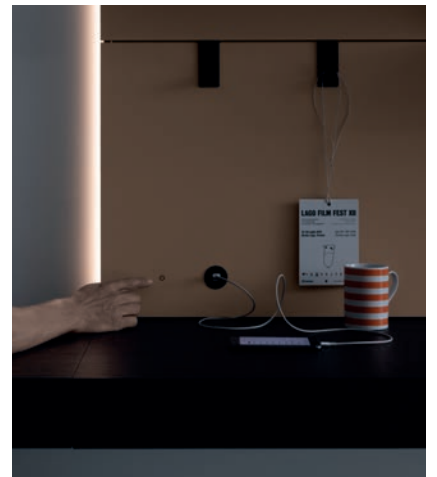

Led lights are dimmable with touch control



1



Rear-back panels



3

Horizontal boiserie panel (* = Upholstered)

59,7 - 89,7 - 119,7 - 149,7 - 179,7 - 209,7 - 239,7 - 269,7 - 299,7 cm
 23 4/8" - 35 3/8" - 47 1/8" - 58 7/8" - 70 5/8" - 82 1/8" - 94 3/8" - 106 1/8" - 118"

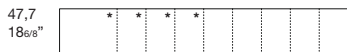
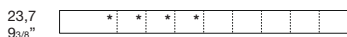
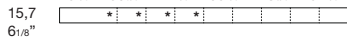

Horizontal boiserie panel near bases (* = Upholstered)

59,7 - 89,7 - 119,7 - 149,7 - 179,7 - 209,7 - 239,7 - 269,7 - 299,7 cm
 23 4/8" - 35 3/8" - 47 1/8" - 58 7/8" - 70 5/8" - 82 1/8" - 94 3/8" - 106 1/8" - 118"

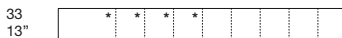
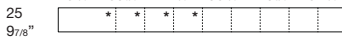

Vertical boiserie panel (* = Upholstered ** = Cork, Mirror)

30 60
11 5/8" 23 5/8"

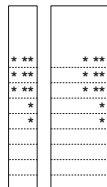

H 64 - 80 - 96 - 112 - 128 - 144 - 160 - 176 - 192 cm
 H 25 1/8" - 31 1/8" - 37 5/8" - 44 1/8" - 50 3/8" - 56 5/8" - 63" - 69 1/8" - 75 5/8"

Metal shelves for Boiserie P 24 cm D 9 1/8"

43,8 58,8 88,8
 17 1/8" 23 1/8" 35"
 0,25
 1/8"

Hook and knob for Boiserie



Avenue Boiserie

DESIGN BY RUGA.PERISSINOTTO & SCIUTO ARCHITETTI, 2021

IT Sintesi di pulizia formale e ricerca tecnica, Avenue Boiserie è un sistema composto da un retro-pannello preforato a cui si applicano pannelli estetici e accessori. La struttura è circondata da un profilo magnetico essenziale e può essere dotata di luce a LED perimetrale, dimmerabile e con accensione integrata. Alla boiserie si applicano mensole metalliche di spessore ridotto, pensili e basi, pannelli in tessuto, specchio o sughero, appendiabiti. La ricchezza degli elementi rispecchia la versatilità del sistema, da interpretare a piacere in base allo spazio disponibile e alle esigenze funzionali.

EN The result of formal simplicity and technical research, Avenue Boiserie is a system consisting of a pre-drilled back panel, to which aesthetic panels and accessories can be attached. The structure is surrounded by a minimalist magnetic profile. It can be fitted with a dimmable perimeter LED light with a built-in switch. Reduced thickness metal shelves, wall and base units, fabric, mirror or cork panels and clothes hooks can be attached to the boiserie. The variety of elements reflects the versatility of the system, which can be adapted as you require, depending on the available space and functional requirements.

DE Das System Avenue Boiserie ist eine gelungene Mischung aus Klarheit und technischer Forschung und besteht aus einer vorgebohrten Rückwandplatte, auf der

Dekor-Paneele und Zubehörteile angebracht werden. Die Struktur wird von einem schlichten Magnetprofil eingefasst und kann mit umlaufender dimmbarer LED-Beleuchtung mit integriertem Einschaltmodul ausgestattet werden. An der Boiserie lassen sich Regalböden aus Metall mit reduzierter Stärke, Ober- und Unterschränke, Stoff-, Spiegel- oder Korkpaneele sowie Kleiderhaken anbringen. Die Fülle der Elemente spiegelt die Vielseitigkeit des Systems wider, das je nach Platzangebot und funktionellen Anforderungen beliebig interpretiert werden kann.

ES Síntesis de limpieza formal e investigación técnica, Avenue Boiserie es un sistema compuesto por un panel trasero perforado sobre el que se aplican paneles de acabado y accesorios. La estructura está circundada por un perfil magnético de aspecto esencial y puede estar dotada de una luz LED perimétrica con intensidad regulable y encendido integrado. En la boiserie se aplican estantes metálicos de espesor reducido, colgantes y muebles bajos, paneles de tejido, espejo o corcho y colgadores. La riqueza de sus elementos refleja la versatilidad del sistema, que permite una libre interpretación en función del espacio disponible y de las exigencias funcionales.

FR Alliance de netteté formelle et recherche technique, Avenue Boiserie est un système se composant d'un panneau arrière pré-percé auquel on fixe des panneaux de finition et des

accessoires. La structure est entourée d'un profil magnétique épuré et peut être dotée d'un éclairage à leds périphérique, dimmable et avec allumage intégré. Il est possible de fixer à l'habillage mural, des étagères métalliques d'une fine épaisseur, des éléments hauts et bas, des panneaux en tissu, miroir ou en liège et des patères. La richesse des éléments reflète la polyvalence du système, que l'on pourra interpréter selon l'espace à disposition et la fonctionnalité recherchée.

Suspended base units for Boiserie P 50 cm D 19^{5/8}"

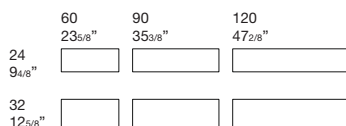

Metal trays P 50 cm D 19^{5/8}"

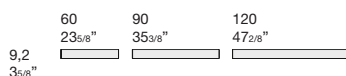

Top for base units P 50 cm D 19^{5/8}"

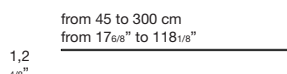

Top for base units/Folder edge shelf P 50 cm D 19^{5/8}"

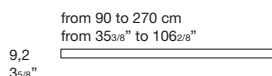

Wall units for Boiserie P 35 cm D 13^{6/8}"

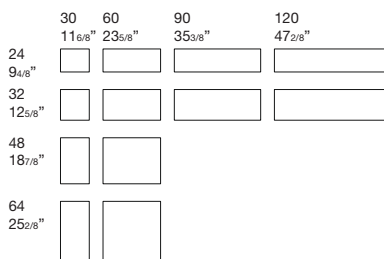

Wall units for Boiserie, 1 open side P 35 cm D 13^{6/8}"



Metal wall units for Boiserie, 1 open side P 35 cm D 13^{6/8}"

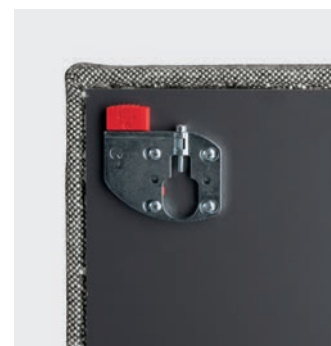

Safety hook



Avenue Cabinets
Matt lacquer, Lacquered metal

Bela armchair
Upholstered in Elmosoft leather

Libro occasional table
Laminate top

Avenue Cabinets





Avenue Cabinets
Matt lacquer, Lacquered metal



1

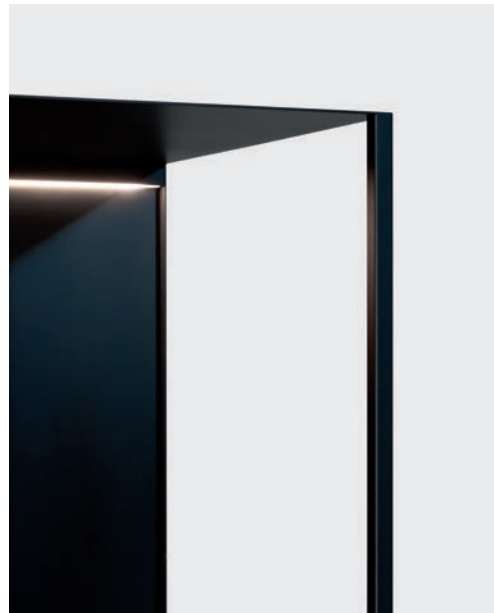

2



1

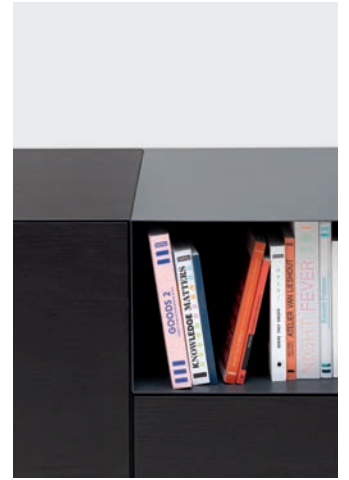

2



Metal base H 24 cm





1



2



3

□ Le madie della collezione Avenue Cabinets nascono dalla combinazione tra contenitori chiusi ed elementi a giorno. Questi ultimi possono essere laccati opachi o in essenza con un solo lato aperto, oppure in metallo, con due lati aperti, personalizzabili nelle finiture e dotati di luce a LED posteriore. Il sistema di aggancio magnetico semplifica l'installazione dei moduli, perfettamente combacianti. La madia può prevedere un basamento, ed essere dunque leggermente sollevata tramite piedini, oppure restare in appoggio a terra.

EN **The cabinets in the Avenue Cabinets collection have been created by combining closed storage units with open elements. The latter are available in matt lacquer or wood veneer, with only one open side, or in metal, with two open sides. They are available in customised finishes and can be fitted with a rear LED light. The magnetic coupling system simplifies the installation of the units, which perfectly match. The cabinet can be supplied with a base, making it slightly raised by the feet, or it can be floor-standing.**

DE Die Sideboards der Kollektion Avenue Cabinets entstehen aus der Kombination zwischen geschlossenen Elementen und offenen Fächern. Letztgenannte sind matt lackiert oder aus Holz mit einer offenen Seite, oder aus Metall mit zwei offenen Seiten erhältlich und stehen in individuellen Ausführungen und einer rückwärtigen LED-Beleuchtung zur Auswahl.

Das magnetische Einhaksystem erleichtert die Montage der perfekt zusammenpassenden Module. Das Sideboard kann mit einem Grundgestell ausgestattet und mittels Füßen leicht angehoben werden, oder ganz einfach direkt auf dem Boden stehen.

ES Las artesas de la colección Avenue Cabinets nacen de la combinación entre módulos contenedores cerrados y elementos abiertos. Estos últimos pueden realizarse en lacado mate o en madera con un solo lado abierto o en metal con dos lados abiertos, con acabados personalizables y luz LED trasera. El sistema de enganche magnético simplifica la instalación de los módulos, que encajan perfectamente entre sí. La artesa puede incluir una base, y estar ligeramente elevada sobre sus patas, o permanecer apoyada en el suelo.

FR Les buffets de la collection Avenue Cabinets ont été créés en alliant des modules à portes à des éléments ouverts. Ces derniers peuvent être laqués mats ou en bois avec un seul côté ouvert ou bien en métal avec deux côtés ouverts. Leurs finitions sont personnalisables et ils peuvent être équipés, à l'arrière, d'un éclairage à leds. Le système d'assemblage magnétique simplifie l'installation de ces modules qui s'unissent ainsi parfaitement. Le buffet peut avoir soit un piétement, et être ainsi légèrement soulevé du sol avec des pieds, soit reposer au sol.



1

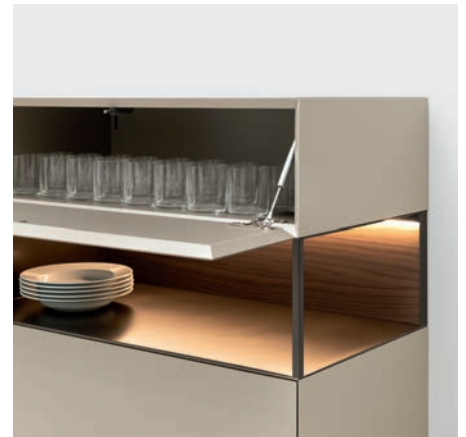

2



1



Metal base H 24 cm



Metal tray



1

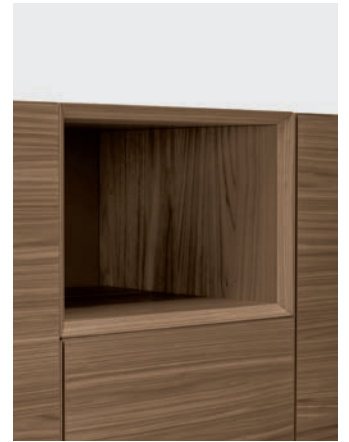

Open unit with 45° profiles



3



4



1



2

Elements P 50 cm D 19 5/8"

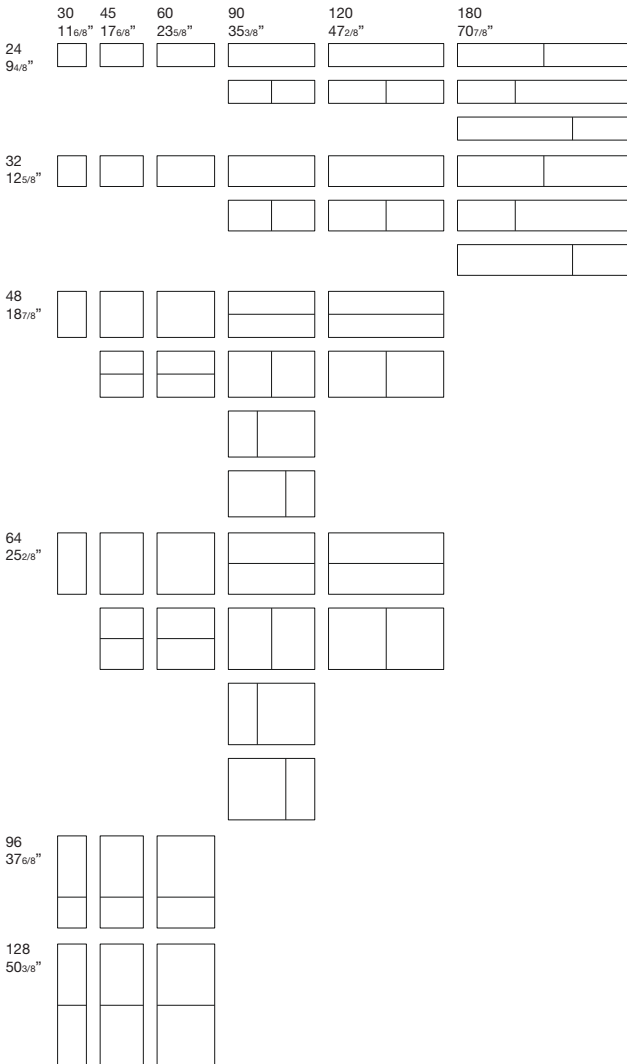

Elements, 1 open side P 50 cm D 19 5/8"

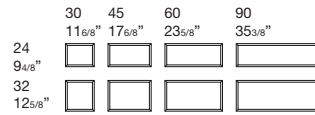

Metal elements, 1 open side P 50 cm D 19 5/8"

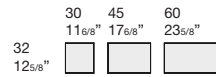

Metal elements, 2 open sides P 50 cm D 19 5/8"

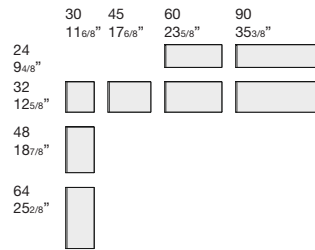

Metal trays P 50 cm D 19 5/8"

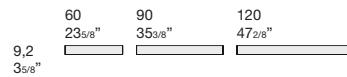

Metal base supports P 42 cm D 16 4/8"

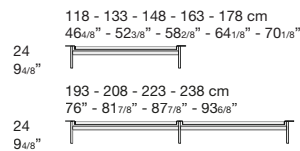

Composition rules

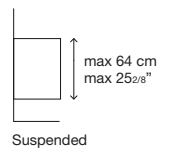
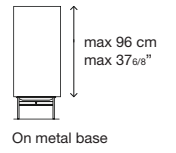
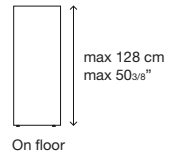

Avenue Cabinets

DESIGN BY RUGA.PERISSINOTTO & SCIUTO ARCHITETTI, 2021

IT Avenue Cabinets è una collezione di madie dal design pulito ed essenziale, i cui elementi replicano nelle dimensioni e nelle finiture quelli del sistema giorno Avenue System, cui naturalmente si accompagnano. Le numerose combinazioni tra moduli chiusi ed elementi aperti sono state studiate per offrire un interessante gioco di proporzioni e volumi, pieni e vuoti, in equilibrio tra estetica e funzionalità.

EN Avenue Cabinets is a collection of cabinets with a clean and essential design. Its elements replicate those of the Avenue System for the living area in size and finish, which they naturally complement. Combinations of closed units and open metal elements are designed to create an interesting interplay of proportions and volumes, open and closed spaces, balancing aesthetic appeal with functionality.

DE Avenue Cabinets ist eine Kollektion von Sideboards mit reinem und essenziellem Design, deren Elemente in Größe und Ausführung denen des offenen Systems Avenue System entsprechen, wodurch sie diese auf natürliche Weise ergänzen. Die zahlreichen Kombinationen aus geschlossenen Modulen und offenen Elementen bieten ein interessantes Wechselspiel aus vollen und leeren Flächen und Volumen und führen zu einem perfekten Gleichgewicht zwischen Ästhetik und praktischem Nutzen.

ES Avenue Cabinets es una colección de artesas de diseño limpio y esencial cuyos elementos

reproducen las dimensiones y los acabados de los del sistema para el salón Avenue System, a los que acompañan con naturalidad. Las numerosas combinaciones entre módulos cerrados y elementos abiertos han sido estudiadas para ofrecer un interesante juego de proporciones y volúmenes y de llenos y vacíos, en equilibrio entre estética y funcionalidad.

FR Avenue Cabinets est une collection de buffets au design net et épuré, dont les éléments reproduisent, dans les dimensions et dans les finitions, ceux du système pour séjour Avenue System auxquels, naturellement, ils s'associent. Les nombreuses combinaisons entre les modules à portes et les éléments ouverts ont été étudiées afin d'offrir un jeu harmonieux de proportions et de volumes, de pleins et de vides, en alliant esthétique et fonctionnalité.

Compositions

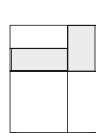

01 rh/lh
L 90 H 112 cm
W 35³/₈" H 44¹/₈"

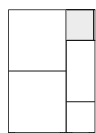

02 rh/lh
L 90 H 128 cm
W 35³/₈" H 50³/₈"

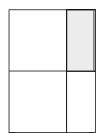

03 rh/lh
L 90 H 128
W 35³/₈" H 50³/₈"

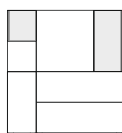

04 rh/lh
L 120 H 128 cm
W 47²/₈" H 50³/₈"

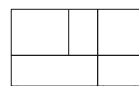

05
L 135 H 80 cm
W 53¹/₈" H 31⁴/₈"

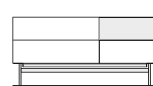

06 rh/lh
L 150 H 72 cm
W 59" H 28³/₈"

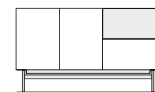

07 rh/lh
L 150 H 88 cm
W 59" H 34⁵/₈"

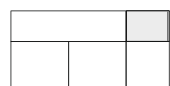

08 rh/lh
L 165 H 80 cm
W 65" H 31⁴/₈"

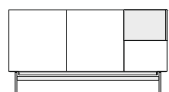

09 rh/lh
L 165 H 88 cm
W 65" H 34⁵/₈"

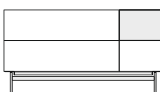

10 rh/lh
L 165 H 88 cm
W 65" H 34⁵/₈"

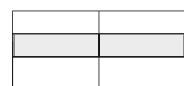

11
L 180 H 80 cm
W 70⁷/₈" H 31⁴/₈"

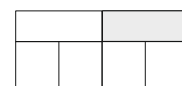

12 rh/lh
L 180 H 80 cm
W 70⁷/₈" H 31⁴/₈"

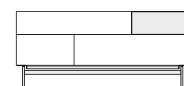

13 rh/lh
L 180 H 80 cm
W 70⁷/₈" H 31⁴/₈"

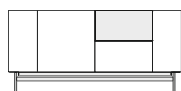

14 rh/lh
L 180 H 88 cm
W 70⁷/₈" H 34⁵/₈"

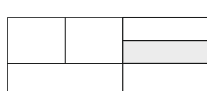

15 rh/lh
L 210 H 88 cm
W 82⁵/₈" H 34⁵/₈"

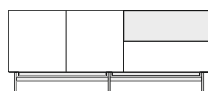

16 rh/lh
L 210 H 88 cm
W 82⁵/₈" H 34⁵/₈"

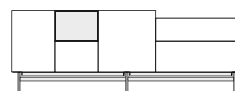

17 rh/lh
L 240 H 88 cm
W 94⁴/₈" H 34⁵/₈"



Aria	76
Novel	104
Telon	104



Aria Battente wardrobe (PROFILO/SIMPLE Lama Lunga)
Metal, Glass, Melamine-faced, Matt lacquer

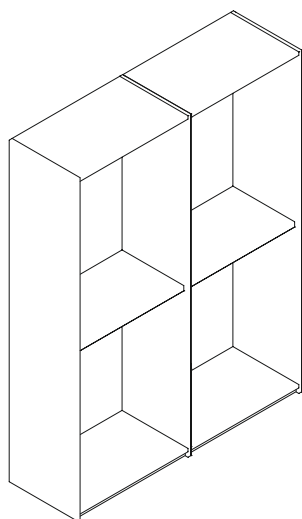

Cabina

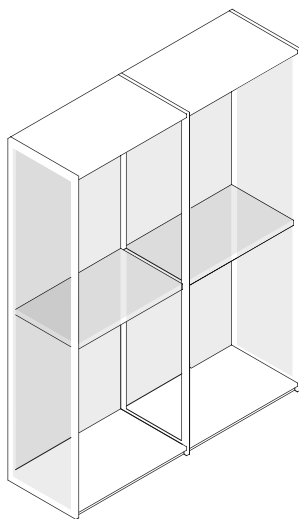

Cabina TELAIO

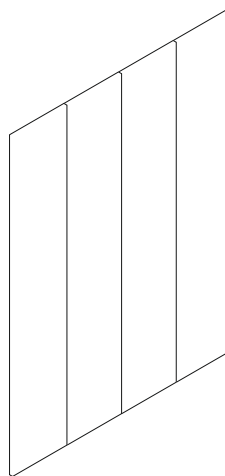

Battente

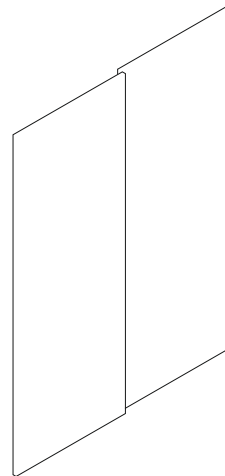

Scorrevole

SIMPLE



GRAFICA



GOLA



PROFILO



TELAIO



SIMPLE



GOLA



PROFILO



TELAIO





Aria Battente wardrobe (PROFILO/SIMPLE Lama Lunga)
Metal, Glass, Melamine-faced, Matt lacquer

Bombosoft bed
Upholstered in Parigi fabric







Suspended drawer units



2



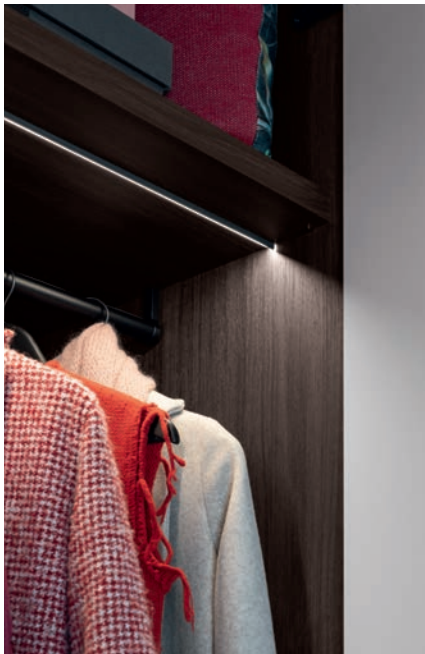

Led lighting



Hanging rod



TELAIO doors hinge



Aria Cabina walk-in closet
Metal, Glass, Melamine-faced

Legri bed
Upholstered in Elmosoft leather

Librio occasional table
Laminate top





Hanging rod



Shoe-rack



1 pull-out shelf and 1 trouser-rack



Plinth filler





Aria Battente wardrobe (SIMPLE Punto+Linea)
Matt lacquer

Clapis bed
Upholstered in Borgo fabric

Librio occasional table
Laminated top



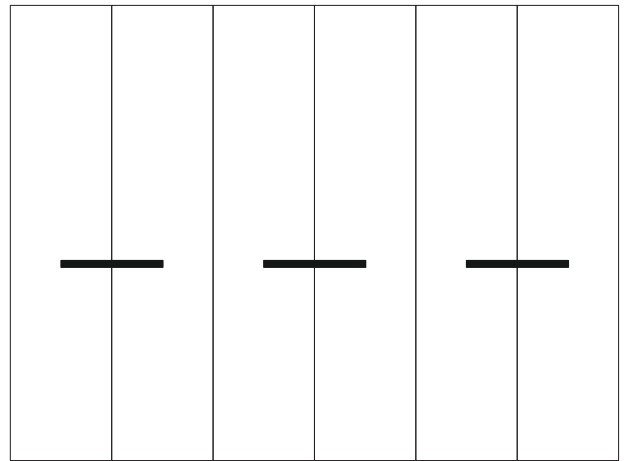
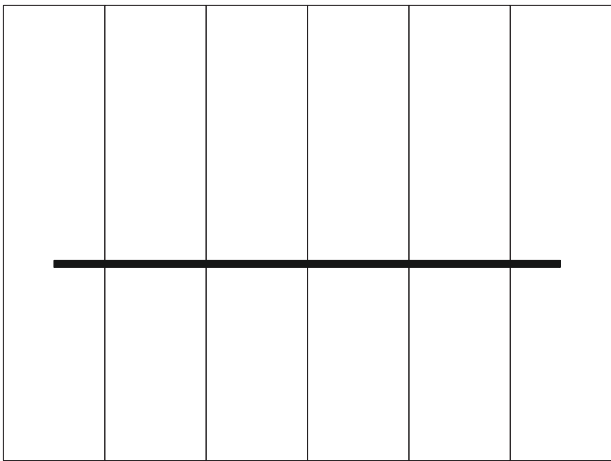
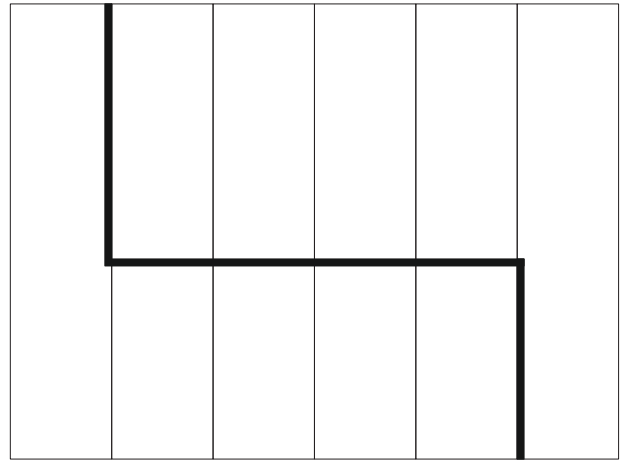
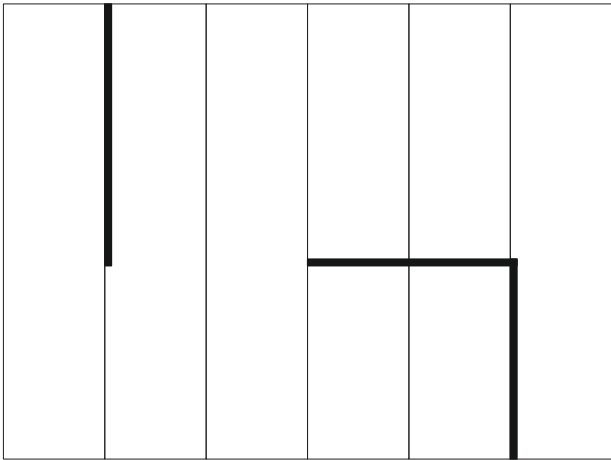
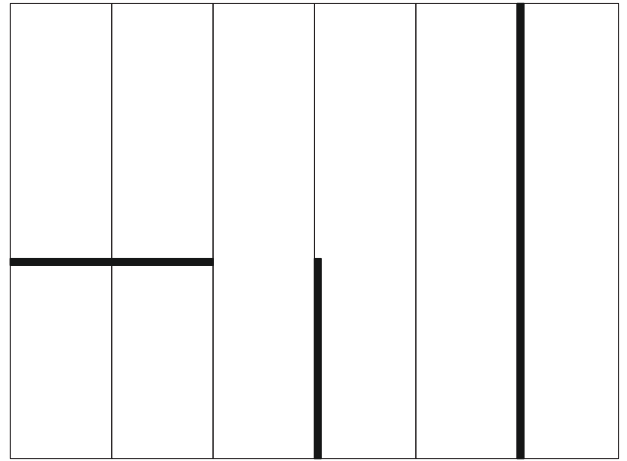
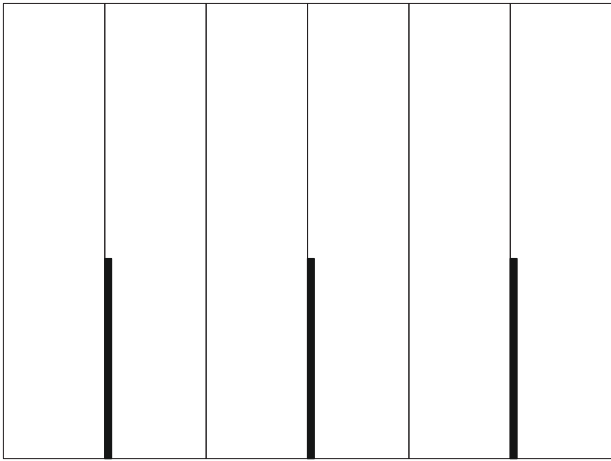

Endless combinations



GRAFICA handle

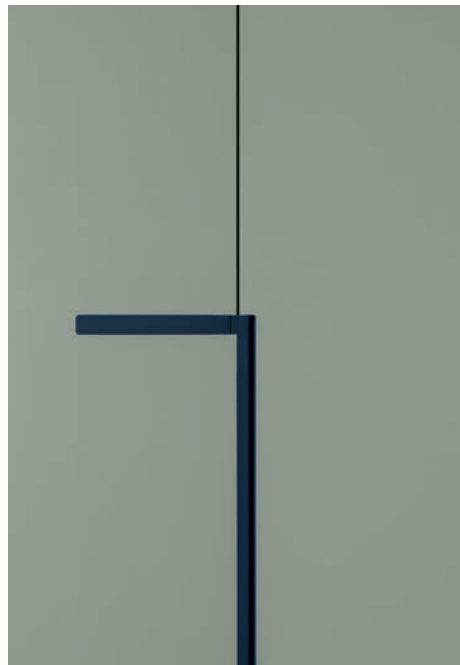

2



Aria Battente wardrobe (GRAFICA)
Matt lacquer, Gloss lacquer, Wood

Clapis bed
Upholstered in Borgo fabric



Valet armchair
Upholstered in Vello fabric



Suspended drawer units



Led lighting

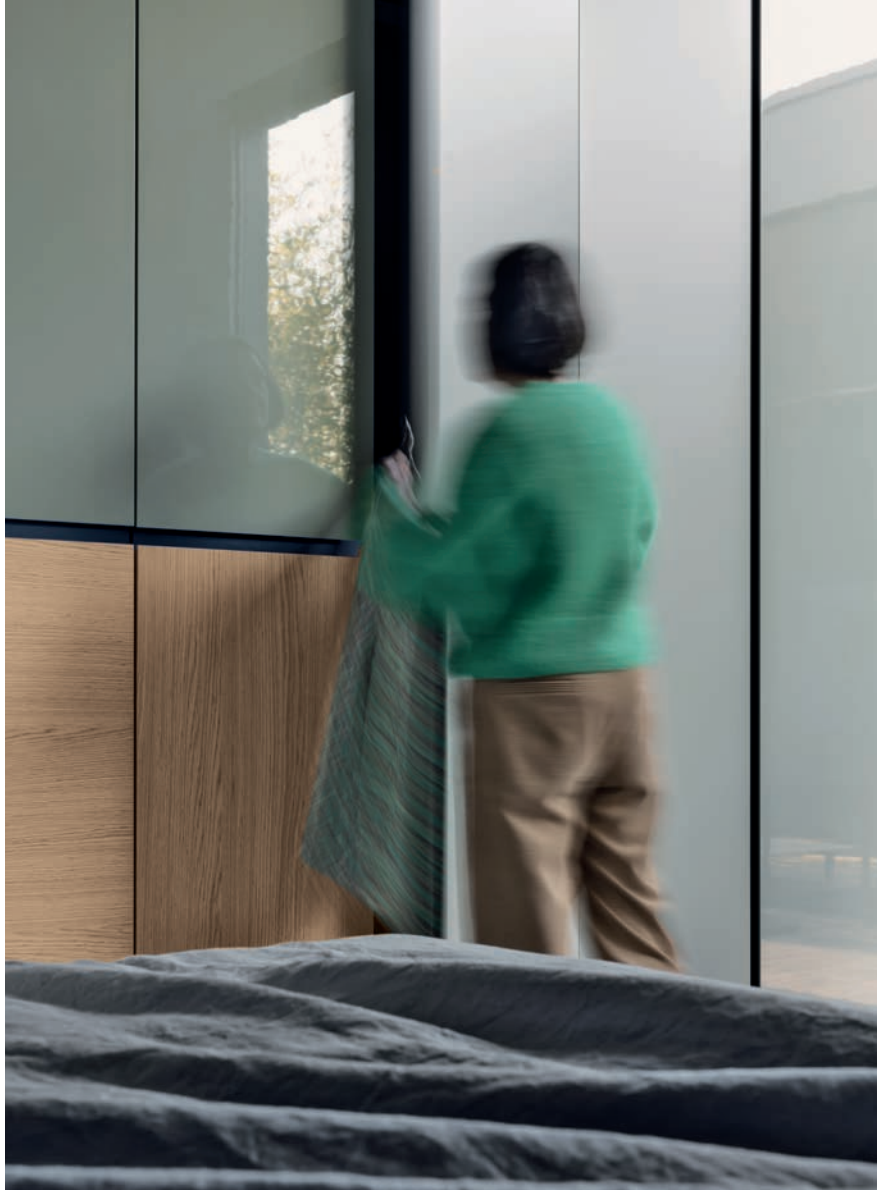



Aria Battente wardrobe (GRAFICA)
Matt lacquer, Gloss lacquer, Wood





GOLA handle



Aria Scorrevole wardrobe (GOLA)
Matt lacquer



SIMPLE /Punto



SIMPLE /Linea



SIMPLE /Punto + Linea

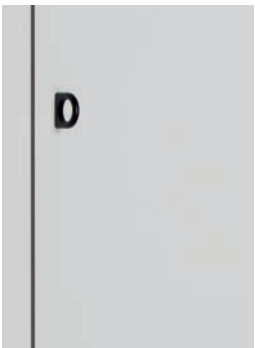

SIMPLE /Anello Corto



SIMPLE /Anello Lungo



SIMPLE /Basic Corta (horizontal)



SIMPLE /Basic Corta (vertical)



SIMPLE /Basic Media



SIMPLE /Basic Lunga

Aria



GOLA



GRAFICA



SIMPLE / Incavo Tondo



SIMPLE / Incavo Ovale



SIMPLE / Incavo Rettangolare



SIMPLE / Lama Corta



SIMPLE / Lama Media



SIMPLE / Lama Lunga

Aria

DESIGN BY RUGA.PERISSINOTTO & SCIUTO ARCHITETTI, 2023

IT Aria è un sistema di armadi e cabine armadio che offre la possibilità di combinare tra loro diversi moduli. La struttura, con fianchi chiusi o passanti in alluminio anodizzato Nero o Bronzo, può essere chiusa da ante scorrevoli o battenti in vari materiali, anche in alluminio con vetro a filo. Armadi e cabine si possono attrezzare con cassettiere sospese o a terra, contenitori raster, ripiani estraibili in vetro e alluminio, scatole e portaoggetti personalizzati. Nella versione Aria Grafica, le aperture a gola creano interessanti giochi grafici.

EN **Aria is a wardrobe and walk-in wardrobe system that allows a combination of different units. The structure, with closed or through sides in Black or Bronze anodized aluminium, can be closed by sliding or hinged doors in a choice of materials, also in aluminium with flush glass. Wardrobes and walk-in wardrobes can be fitted with suspended or floor-standing drawer units, storage racks, glass and aluminium pull-out shelves, boxes and customised accessory holders. In the Aria Grafica version, grip recess openings create interesting graphic effects.**

DE Aria ist ein Anbausystem für Schränke und Schrankkabinen, das die Möglichkeit bietet, verschiedene Module untereinander zu kombinieren. Die Struktur, mit geschlossenen oder offenen Seitenwänden aus eloxiertem Aluminium in den Farben Schwarz oder Bronze, kann mit Schiebe- oder Drehtüren aus

unterschiedlichen Materialien verschlossen werden, darunter auch Aluminium mit flächenbündiger Glasfüllung. Die Schränke und Kabinen lassen sich mit hängenden oder bodenstehenden Schubladenelementen, Fächerelementen, ausziehbaren Fachböden aus Glas und Aluminium sowie individuell gestaltbaren Schachteln und Ablagen ausstatten. Bei der Version Aria Grafica erzeugen die zum Öffnen eingesetzten Hohlkehlen interessante grafische Effekte.

ES Aria es un sistema de armarios y vestidores que ofrece la posibilidad de combinar diversos módulos entre sí. La estructura, con costados cerrados o pasantes en aluminio anodizado Negro o Bronce, puede completarse con puertas correderas o batientes de distintos materiales, incluso en aluminio con cristal al ras. Los armarios y los vestidores pueden equiparse con cajoneras suspendidas o de suelo, casilleros, baldas extraíbles de cristal y aluminio, cajas y portaobjetos personalizados. En la versión Aria Grafica, las golas de apertura crean interesantes juegos gráficos.

FR Aria est un système d'armoires et de dressings, qui offre la possibilité de combiner divers modules. La structure avec côtés fermés ou ouverts, en aluminium anodisé Noir ou Bronze, peut être fermée par des portes coulissantes ou battantes réalisées en divers matériaux, également en aluminium avec vitre à fleur. Les armoires et les dressings peuvent être

aménagés avec des blocs-tiroirs suspendus ou posant au sol, des casiers, des étagères coulissantes en verre et en aluminium, des boîtes et des porte-objets personnalisés. Dans la version Aria Grafica, les ouvertures sur gorge créent des jeux graphiques tout à fait intéressants.

Shelf P 54 cm D 21²/₈"

	37,5 14 ⁶ / ₈ "	47,5 18 ⁶ / ₈ "	57,5 22 ⁵ / ₈ "	77,5 30 ⁴ / ₈ "	97,5 38 ³ / ₈ "	117,5 46 ² / ₈ "	147,5 58 ¹ / ₈ "
3,5 1 ³ / ₈ "							

Shoe-rack P 54 cm D 21²/₈"

	47,5 18 ⁶ / ₈ "	57,5 22 ⁵ / ₈ "	77,5 30 ⁴ / ₈ "	97,5 38 ³ / ₈ "	117,5 46 ² / ₈ "
2,5 1"					

Hanging rod Ø 3,5 cm Ø 1³/₈"

	37,5 14 ⁶ / ₈ "	47,5 18 ⁶ / ₈ "	57,5 22 ⁵ / ₈ "	77,5 30 ⁴ / ₈ "	97,5 38 ³ / ₈ "	117,5 46 ² / ₈ "	147,5 58 ¹ / ₈ "
7 2 ⁶ / ₈ "							

Drawer unit w/ 2 doors P 48,5 cm D 19¹/₈"

	77,5 30 ⁴ / ₈ "	97,5 38 ³ / ₈ "
38,4 15 ¹ / ₈ "		

Drawer unit w/ 3 doors P 48,5 cm D 19¹/₈"

	47,5 18 ⁶ / ₈ "	57,5 22 ⁵ / ₈ "	77,5 30 ⁴ / ₈ "	97,5 38 ³ / ₈ "	117,5 46 ² / ₈ "
57,6 22 ⁵ / ₈ "					

Pull-out accessories

	1 shelf L 97,5 P 48,5 H 13 cm W 38 ³ / ₈ " D 19 ¹ / ₈ " H 5 ¹ / ₈ "		3 shelves L 97,5 P 48,5 H 32 cm W 38 ³ / ₈ " D 19 ¹ / ₈ " H 12 ⁵ / ₈ "
	1 trouser-rack L 97,5 P 48,5 H 13 cm W 38 ³ / ₈ " D 19 ¹ / ₈ " H 5 ¹ / ₈ "		1 shelf + 1 shoe-rack L 97,5 P 48,5 H 32 cm W 38 ³ / ₈ " D 19 ¹ / ₈ " H 12 ⁵ / ₈ "
	2 shelves L 97,5 P 48,5 H 22 cm W 38 ³ / ₈ " D 19 ¹ / ₈ " H 8 ⁵ / ₈ "		1 shelf + 1 trouser-rack L 97,5 P 48,5 H 22 cm W 38 ³ / ₈ " D 19 ¹ / ₈ " H 8 ⁵ / ₈ "
	1 shoe-rack L 97,5 P 48,5 H 22 cm W 38 ³ / ₈ " D 19 ¹ / ₈ " H 8 ⁵ / ₈ "		



Novel closet
Lacquered metal, Matt lacquer

Telon curtain integrated
Lino Lino fabric

Legri bed
Upholstered in Elmosoft leather

Librio occasional table
Laminate top

Novel + Telon



Valet armchair
Upholstered in Moss fabric



1



2

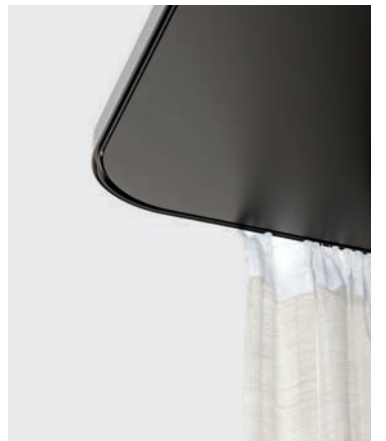

3



1

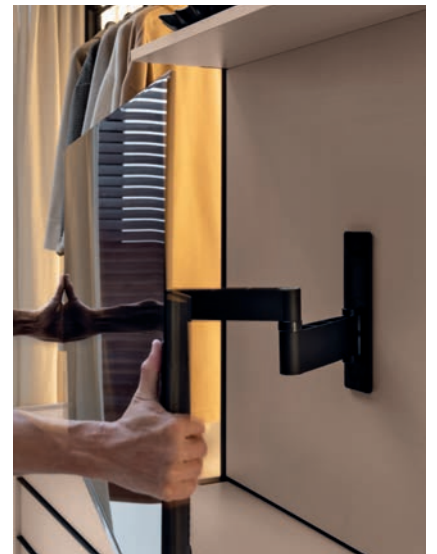

Swivel and extendable TV support



Novel closet
Lacquered metal, Matt lacquer

Telon curtain integrated
Twilight fabric

Novel Island
Melamine-faced

Avenue Boiserie
Wood, Mirror, Lacquered metal



Bombosoft bed
Upholstered in Parigi fabric





Novel closet
Pull-out drawer



1



Twilight fabric by Kvadrat

□ Uno spazio compatto da dedicare all'home office o da usare come vanity corner, nascosto all'occorrenza dalle tende Telon. Basta integrare al sistema Novel il contenitore con cassetto estraibile: prese USB e caricabatterie a induzione si integrano al piano su richiesta, dando vita a un angolo perfetto per lavorare. Il vanity corner si completa invece con Novel Mirror, uno specchio da appoggio con luce a LED integrata e dimmerabile, con illuminazione studiata per arrivare al volto in modo indiretto.

EN **A compact space for devoting to the home office or used as a vanity corner, concealed, if required, by Telon curtains. The Novel system can be easily combined with a storage unit with pull-out drawer: USB sockets and induction battery chargers are incorporated into the top on demand, creating the perfect work corner. The vanity corner is complemented by the Novel Mirror, a countertop mirror with an incorporated dimmable LED light. The lighting is designed to shine indirectly on the face.**

DE Ein kompakter Bereich für das Home Office oder die Schminkecke, der sich bei Bedarf hinter Vorhängen aus Telon verbirgt. Es genügt, das System Novel mit dem Element mit ausziehbarer Schublade zu ergänzen: USB-Steckdosen und Induktionsladegeräte werden auf Anfrage in die Platte integriert und schaffen so den perfekten Arbeitsplatz. Die Schminkecke wird hingegen mit NovelMirror vervollständigt, einem Standspiegel

mit integrierter und dimmbarer LED-Beleuchtung, der das Gesicht auf indirekte Weise erhellt.

ES Un espacio compacto para dedicar a la oficina doméstica o utilizar como tocador escondiéndolo cuando es oportuno con las cortinas Telon. Basta incluir en el sistema Novel el contenedor con cajón extraíble: a petición del cliente, las tomas USB y los cargadores por inducción se incorporan en el sobre dando vida a un espacio perfecto para trabajar. El tocador se completa en cambio con Novel Mirror, un espejo de apoyo con luz LED integrada y regulable cuya una iluminación ha sido estudiada para alcanzar la cara de forma indirecta.

FR Un espace compact que l'on pourra aménager avec un coin Home office ou une coiffeuse et masquer, si nécessaire, avec les rideaux Telon. Il suffira d'associer au système Novel l'élément suspendu avec tiroir: sur commande, il sera possible d'installer sur son plateau des prises USB et un chargeur de batteries à induction, en créant ainsi un coin parfait pour travailler. En revanche, pour la coiffeuse, on pourra ajouter Novel Mirror, un miroir à poser intégrant un éclairage à leds dimmable, avec une lumière étudiée pour arriver de manière indirecte sur le visage.

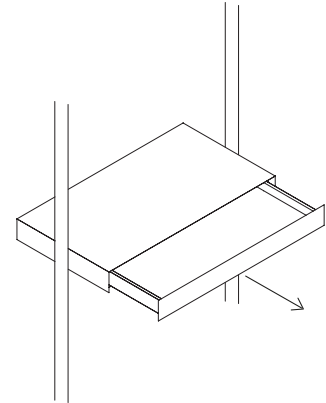

Pull-out drawer



2



Novel closet
Lacquered metal, Melamine-faced

Novel Mirror
Matt lacquer, Mirror

Valet armchair
Upholstered in Vello fabric



Telon curtain
Zulu 2 fabric



Novel closet
Swivel mirror



Novel Mirror
Matt lacquer, Mirror



Led lighting



Hanging rod

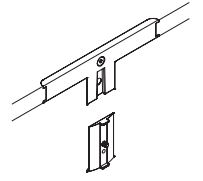

Shelf support



1 pull-out shelf and 1 trouser-rack



Drawer unit w/ 2 drawers

▣ La cabina armadio Novel si completa con una serie di accessori progettati per soddisfare ogni tipo di necessità. Dal set di vassoi componibili e combinabili pensati per contenere gioielli, orologi e piccoli accessori ai porta pantaloni e porta biancheria in alluminio; dai porta scarpe fissi o estraibili ai tappetini da applicare al top delle cassettiere; dall'illuminazione dimmerabile da controllare con telecomando agli specchi.

EN **The Novel walk-in wardrobe is complemented with a range of accessories designed to meet all needs. They include a set of modular and combinable trays designed to hold jewellery, watches and small accessories, aluminium trouser-racks and laundry bins, fixed or pull-out shoe racks, mats for placing on top of drawer units, dimmable lighting with remote control, as well as mirrors.**

DE Die Schrankkabine Novel bietet eine Reihe von Zubehörteilen, die allen Anforderungen gerecht werden. Von anbaufähigen und kombinierbaren Tabletts für die Aufbewahrung von Schmuck, Uhren und kleine Accessoires bis hin zu Hosenhängern und Wäscheböden aus Aluminium, von festen oder ausziehbaren Schuhablagen bis hin zu Matten, die an der Abdeckplatte der Schubladenelemente befestigt werden können, und von dimmbarer Beleuchtung mit Fernbedienung bis hin zu Spiegeln.

ES El vestidor Novel se completa con una serie de accesorios diseñados para satisfacer todo tipo de necesidades. Del juego de bandejas componibles y combinables pensadas para guardar joyas, relojes y pequeños accesorios a los pantalonereros o cesta para la ropa; de los zapateros fijos o extraíbles a las alfombrillas que se aplican en la encimera de las cajoneras; de la iluminación regulable con mando a distancia a los espejos.

FR Le dressing Novel peut être équipé d'une série d'accessoires conçus pour répondre à tout type de nécessités: ensemble de plateaux composables et amovibles pour ranger les bijoux, les montres et les petits accessoires; porte-pantalons et paniers à linges coulissants en aluminium; range-chaussures fixes ou coulissants; tapis à fixer au plateau des blocs-tiroirs; éclairage dimmable réglable avec télécommande; miroirs.



Pull-out shoe-rack

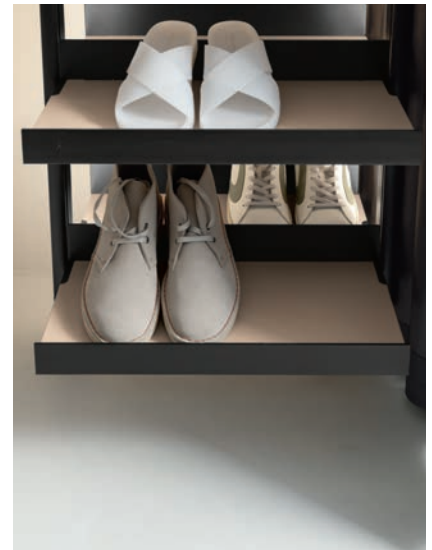

Shoe-rack



47,5 18⁶/₈"
 77,5 30⁴/₈"
 97,5 38³/₈"
 117,5 46²/₈"

47,5 18⁶/₈"
 77,5 30⁴/₈"
 97,5 38³/₈"
 117,5 46²/₈"

47,5 18⁶/₈"
 77,5 30⁴/₈"
 97,5 38³/₈"
 117,5 46²/₈"

77,5 30⁴/₈"
 97,5 38³/₈"

77,5 30⁴/₈"
 97,5 38³/₈"



97,5 38³/₈"

97,5 38³/₈"

97,5 38³/₈"

97,5 38³/₈"

97,5 38³/₈"



97,5 38³/₈"
117,5 46²/₈"

97,5 38³/₈"
117,5 46²/₈"

77,5 30⁴/₈"
97,5 38³/₈"
117,5 46²/₈"



Without mat



Faux leather mat



Extra thick hide mats



Telon curtain
Twilight fabric

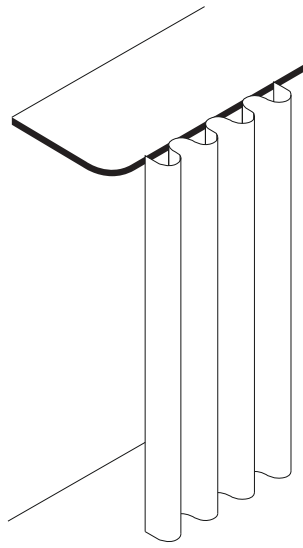

Cielo

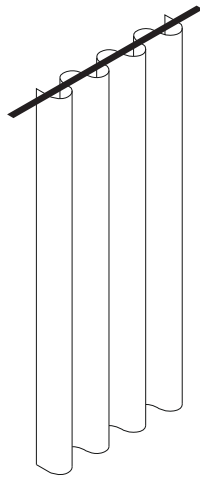

Ceiling

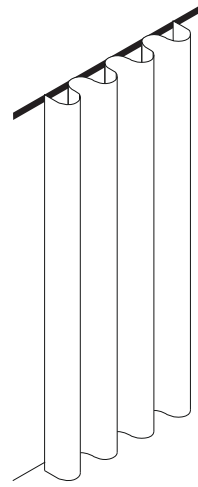

Wall



Storage boxes



Ceiling support



Wall support

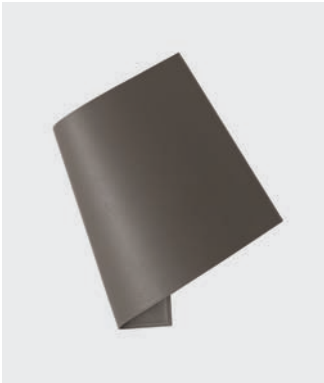

Faux leather mat



Multi use trays



Adjustable feet

Ceiling support

Max H 350 cm H 137⁵/₈"



Wall support

H 236,8 cm H 93²/₈"
H 256 cm H 100⁶/₈"



Cielo support

H 236,8 cm H 93²/₈"
H 256 cm H 100⁶/₈"

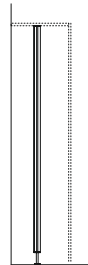

Shelf P 54 cm D 21²/₈"

	47,5 18 ⁵ / ₈ "	77,5 30 ⁴ / ₈ "	97,5 38 ³ / ₈ "	117,5 46 ² / ₈ "
2,5 1"	—————			

Shelf P 40 cm D 15⁶/₈"

	47,5 18 ⁵ / ₈ "	77,5 30 ⁴ / ₈ "	97,5 38 ³ / ₈ "	117,5 46 ² / ₈ "
2,5 1"	—————			

Shoe-rack P 54 cm D 21²/₈"

	47,5 18 ⁵ / ₈ "	77,5 30 ⁴ / ₈ "	97,5 38 ³ / ₈ "	117,5 46 ² / ₈ "
2,5 1"	—————			

Drawer unit w/ 2 drawers P 53 cm D 20⁷/₈"

	77,5 30 ⁴ / ₈ "	97,5 38 ³ / ₈ "
38,4 15 ¹ / ₈ "	—————	

Drawer unit w/ 3 drawers P 53 cm D 20⁷/₈"

	77,5 30 ⁴ / ₈ "	97,5 38 ³ / ₈ "
57,6 22 ⁵ / ₈ "	—————	

Desk with drawer P 53 cm D 20⁷/₈"

	97,5 38 ³ / ₈ "	117,5 46 ² / ₈ "
11 4 ³ / ₈ "	—————	

Cielo P 63 cm D 24⁶/₈"

	mtl
2,5 1"	—————

Hanging rod Ø 3,5 cm Ø 1³/₈"

	47,5 18 ⁵ / ₈ "	77,5 30 ⁴ / ₈ "	97,5 38 ³ / ₈ "	117,5 46 ² / ₈ "
7 2 ⁶ / ₈ "	—————			

Novel + Telon

DESIGN BY LIEVORE + ALTHERR DÉSILE PARK & RUGA.PERISSINOTTO, 2021

▣ Novel è una struttura metallica da completare con ripiani, pali appendiabiti, illuminazione e accessori, mentre Telon è la tenda che la nasconde alla vista, rivelando all'occorrenza un armadio, uno spazio di lavoro o multimediale, ma anche tutte queste cose assieme. La tenda, oggetto evocativo che rende l'ambiente caldo ed elegante, è una soluzione sostenibile, perché riduce il consumo di materiale; in più, ha una funzione insonorizzante che aiuta a limitare la propagazione del suono nella stanza, preservando l'intimità della zona notte.

EN **Novel is a metal frame that can be complemented with shelves, closet poles, lighting and accessories, whereas Telon is a curtain that hides it from view and reveals, in certain cases, a cupboard, a work area or multimedia space, or even all these things together. The curtain, an evocative accessory that adds warm appeal and elegance to a room, is a sustainable solution as it reduces the consumption of materials. It also plays a soundproofing role, helping to limit sound diffusion in the room, thus preserving the intimacy of the sleeping area.**

DE Novel ist eine Metallstruktur, die mit Fachböden, Kleiderstangen, Beleuchtung und Zubehörteilen ergänzt wird, während Telon der Vorhang ist, der sie vor den Blicken verbirgt und bei Bedarf einen Schrank, einen Arbeits- oder Medienplatz, aber auch all diese Dinge zusammen offenbart. Der Vorhang präsentiert

sich als stimmungsvolles Objekt, das dem Raum Wärme und Eleganz verleiht und durch die Verringerung des Materialverbrauchs eine wirklich nachhaltige Lösung darstellt. Er hat außerdem eine schalldämpfende Funktion, die dazu beiträgt, die Ausbreitung des Schalls im Raum zu begrenzen und die intime Atmosphäre des Schlafbereichs zu bewahren.

ES Novel es una estructura metálica que se completa con baldas, barras de colgar, iluminación y accesorios, mientras que Telon es la cortina que la oculta a la vista revelando un armario o un espacio de trabajo o multimedia cuando es oportuno, ¡o todo esto a la vez! La cortina, objeto evocador que confiere calidez y elegancia al ambiente, es una solución sostenible porque reduce el consumo de material; además, tiene una función insonorizante que contribuye a limitar la propagación del sonido en la habitación, preservando la intimidad del dormitorio.

FR Novel est une structure métallique que l'on pourra aménager avec des étagères, des tringles à vêtements, des éclairages et des accessoires, alors que Telon est le rideau servant à cacher son contenu. Quand on l'ouvre, on pourra y découvrir une armoire, un espace de travail ou multimédia, une coiffeuse ou bien toutes ces choses réunies. Le rideau - objet évocateur qui apporte de la chaleur et de l'élégance à la pièce - est une solution durable parce qu'elle permet de consommer moins de matières. De plus, il a une

fonction anti-bruit qui aide à limiter la propagation du son dans la pièce, en préservant ainsi l'intimité de la chambre à coucher.

Pull-out accessories

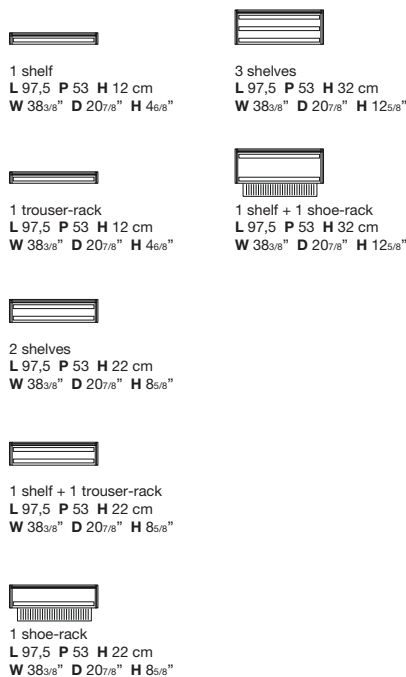

TV panels

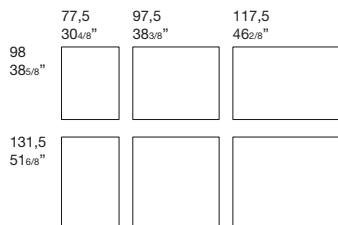

Telon types

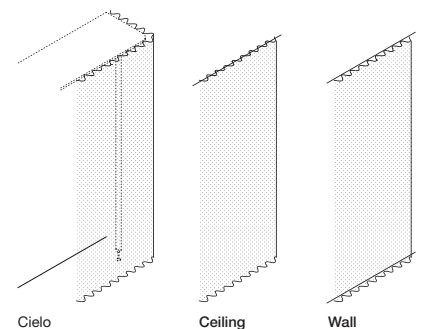

Swivel mirror



L 60 H 160 cm
W 23^{5/8}" H 63"

TV swivel mechanism

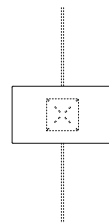



Avenue Boiserie	170
Avenue Night	156
Bombosoft	150
Clapis	128
Legri	142
Novel Island	166
Orbit	162



Clapis bed
Upholstered in Borgo fabric

Tag bedside table
Laminate top

Clapis





Clapis bed
Upholstered in Divina Melange 3 fabric

Orbit night stand
Wood





1

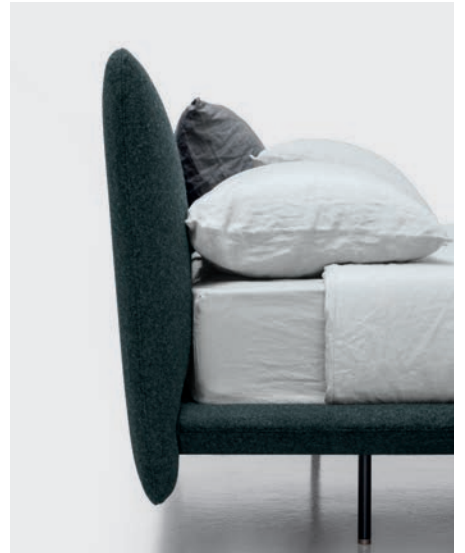

2

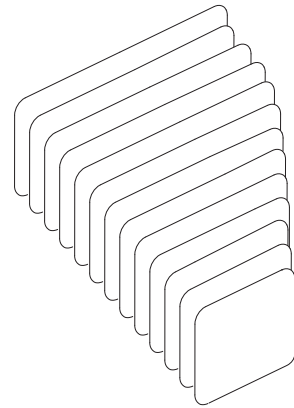

13 different widths

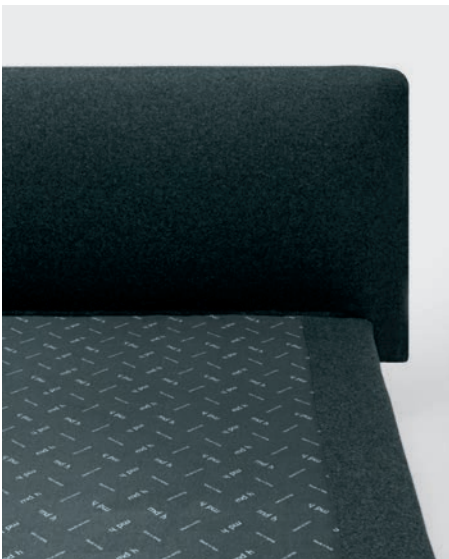

Cover for integrated slatted base

La prima variante del letto Clapis è quella rialzata su piedini, che lo fa sembrare quasi sospeso da terra. Sottili e rientranti, i piedini sono disponibili in due altezze, con puntale in vernice Bronzo leggermente staccato dal resto del piede per enfatizzarne la leggerezza. Il pianale imbottito è caratterizzato da un profilo curvo che valorizza le linee dinamiche del letto ed è realizzato con cura sartoriale, mentre la rete è rivestita con una cuffia coprirete personalizzata. Nella versione più alta, Clapis può ospitare un contenitore sottoletto nero opaco, chiuso con tela personalizzata e clip, a scelta dotato di ruote per essere spostato in modo più agile.

The first variation of the Clapis bed is the raised version on feet, which makes it appear almost suspended from the ground. Slender and recessed, the feet are available in two heights, with a Bronze coated cap slightly detached from the rest of the foot to emphasise its lightness. The upholstered base features a curved profile that enhances the dynamic lines of the bed and is skilfully crafted, whereas the bedspring is covered with a customised bedspring cover. The taller version of Clapis can accommodate a matt black under-bed storage unit, closed with a customised fabric and clips. Optional castors are available for easier movement.

Die erste Variante des Betts Clapis präsentiert sich mit Füßen, wodurch das Modell scheinbar in der Luft zu schweben scheint. Die schlanken,

zurückversetzten Füße stehen in zwei Höhen zur Auswahl, wobei sich das in Farbe Bronze lackierte Endstück vom Rest des Fußes abhebt, um dessen Leichtigkeit zu unterstreichen. Der mit handwerklicher Sorgfalt hergestellte gepolsterte Bettrahmen weist ein abgerundetes Profil auf, das die dynamischen Linien des Bettes unterstreicht. Der Lattenrost ist mit einer maßgeschneiderten Schutzhülle überzogen. Bei der höheren Version lässt sich unter dem Bett Clapis ein Behälter in Farbe Schwarz matt unterbringen, der mit einem individuellen Stoffbezug und Clips verschlossen wird und als Extra mit Rollen für ein leichteres Verstellen ausgestattet werden kann.

La primera variante de la cama Clapis es la versión elevada con patas, que parece suspendida en el suelo. Finas y entrantes, las patas están disponibles en dos alturas, con puntera en barniz Bronce ligeramente separada del resto de la pata para enfatizar su ligereza. Realizado con atención sartorial, el tablero tapizado presenta un perfil curvo que resalta las líneas dinámicas de la cama y está revestido con una funda personalizada para cubrir el somier. En la versión más alta, Clapis puede alojar debajo de la cama un contenedor negro mate revestido en tela personalizada y con cierre a presión que puede dotarse con ruedas para facilitar su desplazamiento.

Le premier modèle du lit Clapis repose sur des pieds, ce qui donne l'impression qu'il est

suspendu. Fins et rentrants, les pieds existent en deux hauteurs au choix. Ils ont un embout laqué Bronze qui est légèrement détaché du reste du pied pour en accentuer la légèreté. Le plan couchage rembourré se distingue par une forme arrondie qui met en valeur les lignes dynamiques du lit et est réalisé avec un soin artisanal alors que le sommier est caché par un tissu personnalisé. Dans sa version plus haute, Clapis peut loger sous le sommier, un bac de rangement laqué noir mat et fermé par un tissu personnalisé doté de boutons-pression. Ce bac pourra, au choix, être monté sur des roulettes afin de le déplacer plus facilement.

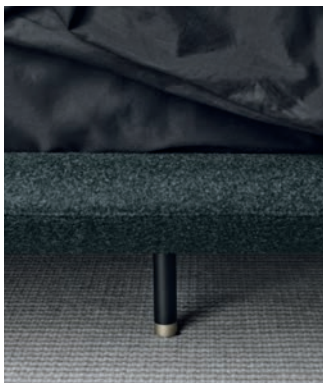

Low feet



High feet



6



1



Storage unit with castors



3



4





1



2



3



4

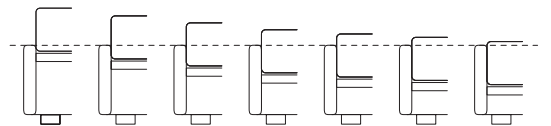
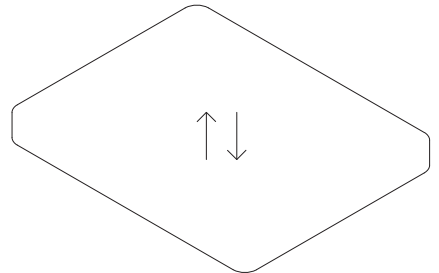

Mattress recessed in 7 different heights

□ La seconda variante del letto Clapis è quella a terra, in tre versioni: sommier, con testiera, con testiera e contenitore. Clapis sommier e Clapis con testiera permettono di scegliere tra sette diverse altezze di incasso da terra del materasso nella struttura, per una più ampia flessibilità ergonomica. Clapis con contenitore è invece dotato di un meccanismo che consente di alzare la rete anche in posizione orizzontale, senza alcun ingombro al di fuori del perimetro del letto. L'interno è personalizzato con pannelli rimovibili e maniglie in cuoio, ed è interamente rivestito con tela logata MD House. Sia sommier sia contenitore si caratterizzano per la struttura imbottita e rivestita con cura sartoriale.

EN **Another variation of the Clapis bed is floor-standing, available in three versions: with a sommier, with a headboard, with a headboard and storage unit. Clapis with a sommier and Clapis with a headboard are available in a choice of seven different heights from the floor for the mattress recessed in the bedframe, for greater ergonomic flexibility. The Clapis bed with a storage unit, on the other hand, is fitted with a mechanism that allows the bedspring to be raised also in a horizontal position, without any encumbrance beyond the perimeter of the bed. The interior is customised with removable panels and handles in hide. It is fully lined with MD House logo fabric. The distinctive features of the sommier and the storage unit version are their skilfully crafted padded and upholstered bedframe.**

DE Die zweite Variante des Betts Clapis wird in drei bodenstehenden Versionen angeboten: als Sommier, mit Kopfteil, mit Kopfteil und Bettkasten. Clapis Sommier und Clapis mit Kopfteil bieten die Möglichkeit, für das Einsetzen der Matratze in die Struktur vom Boden aus sieben verschiedene Höhen auszuwählen, um eine größer ergonomische Anpassbarkeit zu garantieren. Clapis mit Bettkasten ist hingegen mit einem Mechanismus ausgerüstet, der ein Anheben des Lattenrosts auch in waagrechte Position erlaubt, ohne den Platz außerhalb des Betts zu beeinträchtigen. Der Innenraum des Betts ist mit abnehmbaren Platten und Ledergriffen ausgestattet und vollständig mit einem Stoffbezug mit MD House-Logo bezogen. Sowohl das Modell Sommier als auch die Version mit Bettkasten zeichnen sich durch die gepolsterte und nach bester Schneiderkunst bezogene Struktur aus.

ES La segunda variante de la cama Clapis es el modelo de suelo, en tres versiones: turca, con cabecero y con cabecero y canapé. En las versiones turca y con cabecero, Clapis permite elegir entre siete alturas distintas para encastrar el colchón en la estructura, asegurando así la máxima flexibilidad ergonómica. El modelo provisto de canapé está dotado de un mecanismo que permite elevar el somier, incluso en posición horizontal, sin ocupar ningún espacio fuera del perímetro de la cama. El interior está personalizado con paneles desmontables y asas de cuero y está

completamente rivestito con tela decorada con el logotipo MD House. Tanto en la versión turca como en la versión con canapé, la estructura está tapizada y revestida con atención sartorial.

FR Le second modèle du lit Clapis pose au sol et existe en trois versions: sommier tapissier, avec tête de lit, avec tête de lit et coffre. Clapis sommier tapissier et Clapis avec tête de lit offrent la possibilité de choisir sept différentes hauteurs d'encastrement du matelas dans la structure pour une plus vaste flexibilité ergonomique. Clapis avec coffre est, en revanche, doté d'un mécanisme qui permet de relever le sommier même en position horizontale, sans qu'il ne déborde du périmètre du lit. L'intérieur du coffre est personnalisé avec des panneaux amovibles et des poignées en cuir et est entièrement revêtu avec un tissu imprimé avec le logo MD House. Tant la version sommier tapissier que celle avec coffre se distinguent par une structure rembourrée et revêtue avec un soin artisanal.





1



2



3



4



45° lifting mechanism

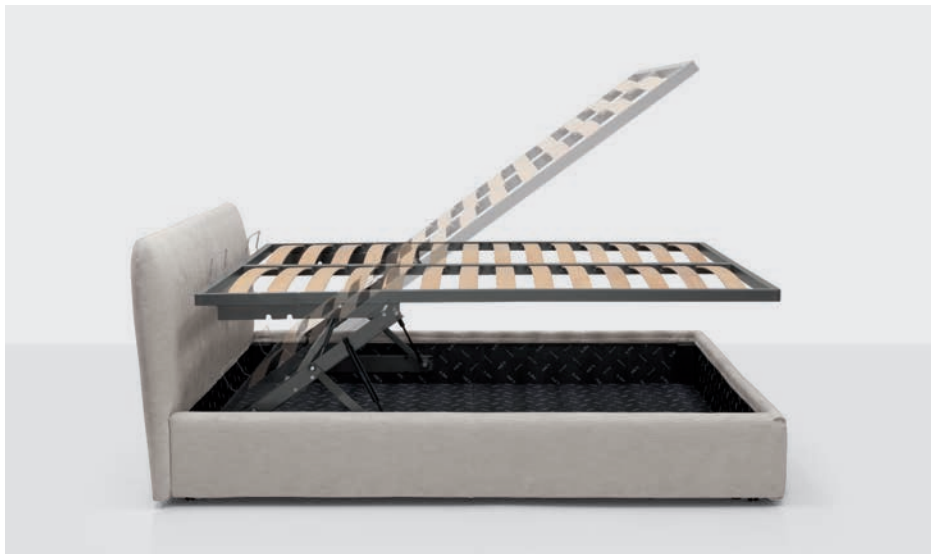

Lifting mechanism 45°+ horizontal



Upholstered in fabric



Upholstered in leather



Clapis on feet



Clapis on floor

Type
H 86 cm
H 33⁷/₈"

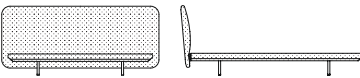

On low feet

H 89 cm
H 35"

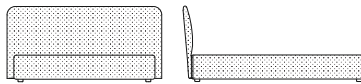

On floor

H 91 cm
H 35⁷/₈"

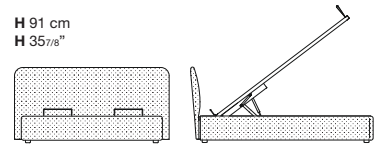

With storage, lifting 45°

H 93 cm
H 35⁵/₈"

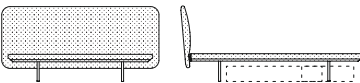

On high feet

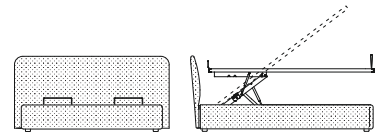

With storage, lifting 45°+ horizontal

For mattresses

L 90 P 200 cm L 153 P 203 cm L 183 P 203 cm
W 35³/₈" D 78⁵/₈" W 60²/₈" D 79⁷/₈" W 74⁶/₈" D 79⁷/₈"

L 100 P 200 cm L 160 P 190 cm L 190 P 200 cm
W 39³/₈" D 78⁶/₈" W 63" D 74⁶/₈" W 74⁶/₈" D 78⁶/₈"

L 120 P 200 cm L 160 P 200 cm L 193 P 203 cm
W 47³/₈" D 78⁶/₈" W 63" D 78⁶/₈" W 76" D 79⁷/₈"

L 140 P 200 cm L 170 P 200 cm
W 55¹/₈" D 78⁶/₈" W 66⁷/₈" D 78⁶/₈"

L 150 P 200 cm L 180 P 200 cm
W 59" D 78⁶/₈" W 70⁷/₈" D 78⁶/₈"

For mattresses

L 90 P 200 cm L 153 P 203 cm L 183 P 203 cm
W 35³/₈" D 78⁵/₈" W 60²/₈" D 79⁷/₈" W 74⁶/₈" D 79⁷/₈"

L 100 P 200 cm L 160 P 190 cm L 190 P 200 cm
W 39³/₈" D 78⁶/₈" W 63" D 74⁶/₈" W 74⁶/₈" D 78⁶/₈"

L 120 P 200 cm L 160 P 200 cm L 193 P 203 cm
W 47³/₈" D 78⁶/₈" W 63" D 78⁶/₈" W 76" D 79⁷/₈"

L 140 P 200 cm L 170 P 200 cm
W 55¹/₈" D 78⁶/₈" W 66⁷/₈" D 78⁶/₈"

L 150 P 200 cm L 180 P 200 cm
W 59" D 78⁶/₈" W 70⁷/₈" D 78⁶/₈"

For mattresses

L 150 P 200 cm L 160 P 200 cm L 183 P 203 cm
W 59" D 78⁶/₈" W 63" D 78⁶/₈" W 74⁶/₈" D 79⁷/₈"

L 153 P 203 cm L 170 P 200 cm L 190 P 200 cm
W 60²/₈" D 79⁷/₈" W 66⁷/₈" D 78⁶/₈" W 74⁶/₈" D 78⁶/₈"

L 160 P 190 cm L 180 P 200 cm L 193 P 203 cm
W 63" D 74⁶/₈" W 70⁷/₈" D 78⁶/₈" W 76" D 79⁷/₈"

Clapis

DESIGN BY BLUEZONE, 2022

☐ Clapis è un letto dall'estetica essenziale, caratterizzato dalla testiera arrotondata come un sasso (clap, in lingua friulana) levigato dall'acqua. È disponibile in quattro varianti: rialzato su piedini sottili e rientranti o a terra, in versione sommier, con testiera e con testiera e contenitore, per ottimizzare lo spazio sotto la rete. Studiato per la migliore comodità ed ergonomia, nelle versioni sommier e a terra con testiera senza contenitore presenta sette possibili altezze nell'incasso tra rete e materasso.

☑ Clapis is a bed with minimalist aesthetic appeal, featuring a headboard rounded like a stone (a 'clap' in the Friulian language) smoothed by water. It is available in four variations: raised on slender recessed feet, floor-standing, a sommier version, with a headboard, and with a headboard and storage unit, to optimise the space under the bedspring. Designed for the greatest comfort and ergonomics, the sommier and the floor-standing versions with a headboard but without a storage unit are available in seven different heights for the mattress recessed in the bedframe.

☒ Clapis ist ein Bett mit essenzieller Ästhetik, das sich durch das abgerundete Kopfteil hervorhebt, das an einen vom Wasser geschliffener Stein (in der friaulischen Sprache clap) erinnert. Es ist in vier Varianten erhältlich: Angehoben auf schlanken, zurückversetzten Füßen oder bodenstehend in den Versionen

Sommier, mit Kopfteil und mit Kopfteil und Bettkasten, um den Stauraum unter dem Lattenrost auszunutzen. Bei der Planung wurde besonders auf Komfort und Ergonomie geachtet, weshalb bei den Versionen mit Kopfteil und ohne Bettkasten sieben verschiedene Einbauhöhen zwischen Lattenrost und Matratze möglich sind.

☑ Clapis es una cama de estética esencial, caracterizada por su cabecero redondeado como un guijarro (clap, en la lengua friulana) pulido por el agua. Está disponible en cuatro variantes: elevada con patas finas y entrantes o de suelo, en versión turca, con cabecero y con cabecero y canapé para optimizar el espacio debajo del somier. Estudiada para garantizar una perfecta ergonomía y comodidad, en la versión turca o de suelo con cabecero sin canapé ofrece siete posibles alturas para el encastre entre el somier y el colchón.

☒ Clapis est un lit avec une esthétique épurée, se distinguant par une tête de lit arrondie comme un caillou (qui se dit « clap » dans la langue frioulane) usé et poli par le frottement de l'eau. Il existe en quatre versions au choix: sur pieds fins et rentrants ou au sol, en version sommier tapissier, avec tête de lit ou bien avec tête de lit et coffre pour optimiser l'espace sous le sommier. Étudié pour le plus grand confort et la meilleure ergonomie, dans les versions sommier tapissier et au sol avec tête de lit sans coffre, il offre sept différentes hauteurs d'encastrement du matelas dans la structure.

H 32 cm
H 12 5/8"



Sommier

H 32 cm
H 12 5/8"

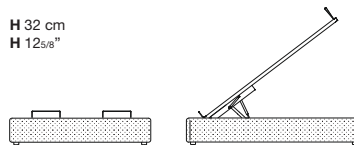

Sommier with storage, lifting 45°

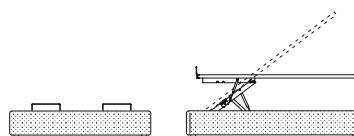

Sommier with storage, lifting 45°+ horizontal

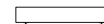

Storage unit under the bed
Available for bed with high feet
L 91 P 61 H 19 cm
W 35 7/8" D 24" H 7 3/8"

L 116 P 51 H 19 cm
W 45 5/8" D 20 1/8" H 7 3/8"

For mattresses

- L 90 P 200 cm L 153 P 203 cm L 183 P 203 cm
W 35 3/8" D 78 5/8" W 60 2/8" D 79 7/8" W 74 5/8" D 79 7/8"
- L 100 P 200 cm L 160 P 190 cm L 190 P 200 cm
W 39 3/8" D 78 5/8" W 63" D 74 5/8" W 74 5/8" D 78 5/8"
- L 120 P 200 cm L 160 P 200 cm L 193 P 203 cm
W 47 3/8" D 78 5/8" W 63" D 78 5/8" W 76" D 79 7/8"
- L 140 P 200 cm L 170 P 200 cm
W 55 1/8" D 78 5/8" W 66 7/8" D 78 5/8"
- L 150 P 200 cm L 180 P 200 cm
W 59" D 78 5/8" W 70 7/8" D 78 5/8"

For mattresses

- L 150 P 200 cm L 160 P 200 cm L 183 P 203 cm
W 59" D 78 5/8" W 63" D 78 5/8" W 74 5/8" D 79 7/8"
- L 153 P 203 cm L 170 P 200 cm L 190 P 200 cm
W 60 2/8" D 79 7/8" W 66 7/8" D 78 5/8" W 74 5/8" D 78 5/8"
- L 160 P 190 cm L 180 P 200 cm L 193 P 203 cm
W 63" D 74 5/8" W 70 7/8" D 78 5/8" W 76" D 79 7/8"



photo © David Toth



1



2

Legri





Legri bed
Upholstered in Elmosoft leather

Valet armchair
Upholstered in Moss fabric

Tag occasional table
Laminate top





Multi-layer natural wood boards



2



3

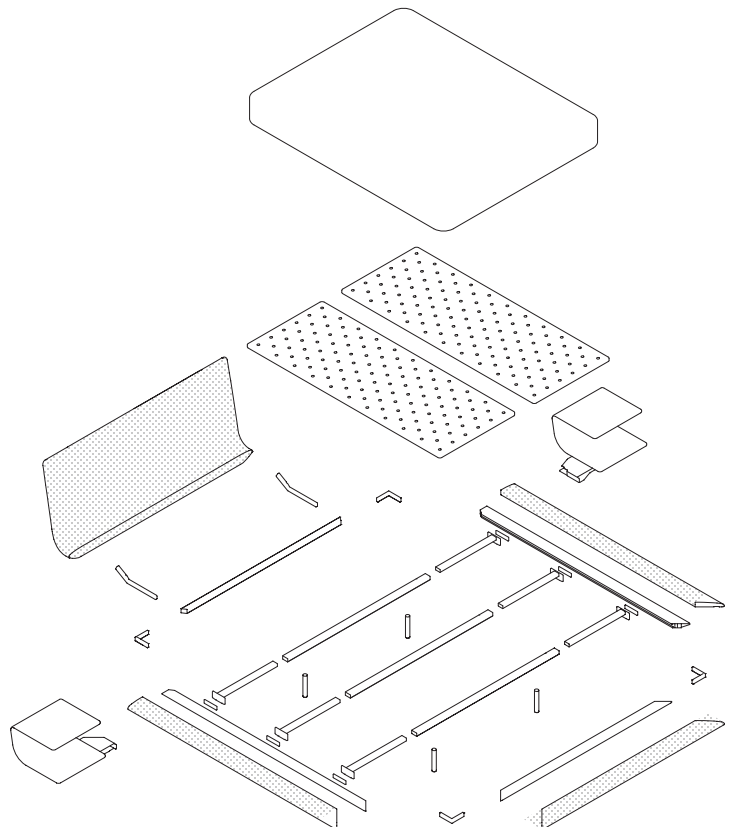

4

□ La struttura del letto Legri si completa con tavole forate in multistrati di legno naturale, che permettono la perfetta integrazione a filo della struttura e un'estrema flessibilità dimensionale. L'illuminazione è integrata, e può comprendere la luce di cortesia, che si aziona automaticamente quando si scende dal letto grazie a un sensore di presenza nascosto, e un'ulteriore luce regolabile, da attivare con l'interruttore nascosto nella struttura nei comodini.

EN **The bedframe of the Legri bed is complemented with perforated boards made of multi-layer natural wood, allowing perfectly flush integration with the frame and exceptional dimensional flexibility. It has incorporated lighting, and can include a courtesy light, which is automatically activated when getting out of bed thanks to a hidden presence sensor. An additional dimmable light can be activated which has a concealed switch concealed in the night stand structure.**

DE Die Struktur des Betts Legri wird durch gelochte Platten aus natürlichem Mehrschichtenholz vervollständigt, die eine perfekte, flächenbündige Anpassung an den Bettrahmen und eine extreme Flexibilität bei den Abmessungen ermöglichen. Die Beleuchtung ist integriert und kann aus einem Nachtlicht bestehen, das sich dank eines versteckten Bewegungssensors beim Aufstehen automatisch einschaltet. Außerdem ist noch ein zusätzliches

dimmbares Licht möglich, das sich mit einem in der Nachttischstruktur verborgenen Schalter einschalten lässt.

ES La estructura de la cama Legri se completa con tablas perforadas realizadas en multicapa de madera natural que permiten una perfecta integración al ras de la estructura, asegurando una extraordinaria flexibilidad dimensional. La iluminación está incorporada y puede incluir la luz de cortesia, que se acciona automáticamente al bajar de la cama gracias a un sensor de presencia oculto, y una luz regulable adicional que se activa con el interruptor escondido en la estructura de las mesitas.

FR La structure du lit Legri s'associe à un plan couchage réalisé avec des planches perforées en multiplis de bois naturel qui s'installent à fleur de la structure et qui ont une extrême flexibilité dans les dimensions. L'éclairage est intégré et peut également comprendre une lumière d'appoint, qui s'actionne automatiquement lorsqu'on se lève du lit grâce à un détecteur de présence, ainsi qu'une autre lumière réglable qui s'allume avec l'interrupteur caché dans la structure des chevets.

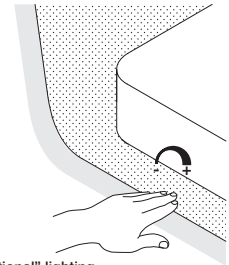

"Emotional" lighting

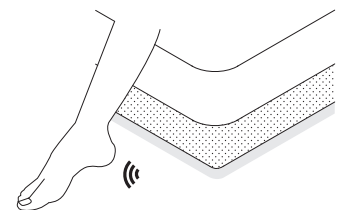

"Courtesy" lighting



Integrated lighting

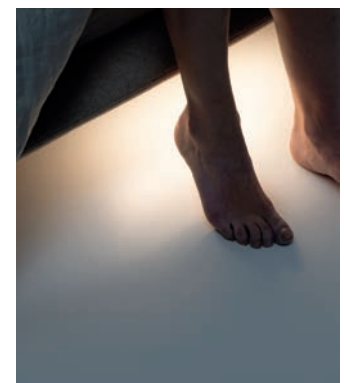



Legri nightstand

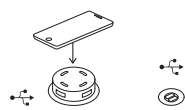

Wireless phone + USB charger



USB charger

Legri

DESIGN BY LIEVORE + ALTHERR DÉSILE PARK, 2021

▣ Come una linea orizzontale tracciata dalla parete al centro della stanza, il letto Legri sembra librarsi in aria, trasmettendo una sensazione di sospensione e leggerezza. Merito dei piedini rientranti rispetto alla struttura, che assicurano stabilità senza farsi notare.

La struttura con schienale imbottito ha linee morbide e rotonde, per la massima sensazione di comfort. Sospesi e curvi anche i comodini, che si possono integrare al letto.

EN **Like a soft horizontal line highlighted by the wall, in the middle of the room the Legri bed appears to hover in the air, evoking a feeling of suspension and lightness.**

This is achieved with the feet, which are recessed in relation to the bedframe, ensuring stability without being noticed. With a padded back panel, the bedframe has soft, rounded lines for maximum comfort.

Night stands, also suspended and curved, can be combined with the bed.

DE Wie eine waagrechte, von der Wand in die Mitte des Raumes reichende Linie scheint das Bett Legri in der Luft zu schweben und vermittelt ein Gefühl von Schwerelosigkeit und Leichtigkeit. Ein Verdienst der im Vergleich zur Struktur zurückversetzten Füße, die Standfestigkeit gewährleisten, ohne aufzufallen. Die Struktur mit gepolstertem Kopfteil besitzt weiche, runde Linien und schenkt höchsten Komfort. Wandhängend und gerundet sind auch die Nachttische, die in das Bett integriert werden können.

ES Como una línea horizontal trazada desde la pared hasta el centro de la habitación, la cama Legri transmite la sensación de estar suspendida en el aire, flotando con ligereza. Mérito de las patas entrantes respecto a la estructura, que aseguran su estabilidad sin hacerse notar. La estructura con trasera tapizada se distingue por sus líneas suaves y redondeadas, que ofrecen una extraordinaria sensación de confort. Suspendidas y curvas también, las mesitas pueden integrarse en la cama.

FR Comme une ligne horizontale tracée depuis le mur jusqu'au milieu de la pièce, le lit Legri semble flotter dans l'air, en transmettant une sensation de suspension et de légèreté. Cela est possible grâce aux pieds rentrants par rapport à la structure du lit, qui en assurent la stabilité sans être vus. La structure avec dossier rembourré a des lignes douces et arrondies qui offrent une sensation de confort maximal. Les chevets, qui se fixent à la structure du lit, sont eux aussi suspendus et ont des lignes arrondies.

Type

H 86 cm
H 33⁷/₈"

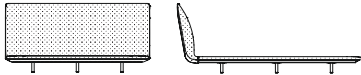

On low feet

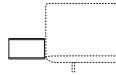

Night stand rh/lh
L 47 P 47 H 27 cm
W 18⁴/₈" D 18⁴/₈" H 10⁵/₈"

H 98 cm
H 38⁵/₈"

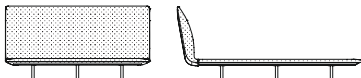

On high feet

For mattresses

L 150 P 200 cm L 160 P 200 cm L 190 P 200 cm
W 59" D 78⁶/₈" W 63" D 78⁶/₈" W 74⁶/₈" D 78⁶/₈"

L 153 P 203 cm L 180 P 200 cm L 193 P 203 cm
W 60²/₈" D 79⁷/₈" W 70⁷/₈" D 78⁶/₈" W 76" D 79⁷/₈"

L 160 P 190 cm L 183 P 203 cm
W 63" D 74⁶/₈" W 74⁶/₈" D 79⁷/₈"





Bombosoft





Bombosoft bed
Upholstered in Parigi fabric

Tag bedside table
Laminate top

Avenue Boiserie
Wood, Matt lacquer, Mirror, Lacquered metal

Bela armchair
Upholstered in Moss fabric



Telon curtain
Zulu 2 fabric



1



2



3

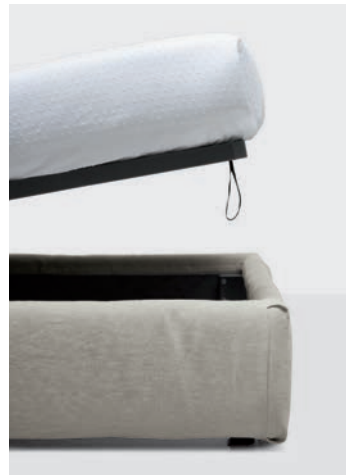

4

Bombosoft

DESIGN BY BLUEZONE, 2022

I Bombosoft è un letto imbottito con testiera dall'estetica morbida e accogliente. Le imbottiture generose e lo schienale soffice suggeriscono, anche visivamente, un'idea di relax e di comfort. La cura dei particolari è sartoriale. Bombosoft è disponibile sia in versione sommier sia con contenitore. In quest'ultimo caso, è dotato di un meccanismo che consente di alzare la rete in due posizioni, a 45° o in orizzontale, mentre l'interno è personalizzato con pannelli rimovibili e maniglie in cuoio, nonché interamente rivestito.

EN Bombosoft is a padded bed with a soft and cosy headboard. The generous padding and soft backrest suggest, also visually, an idea of relaxation and comfort. All details are skilfully crafted. Bombosoft is available in a sommier version, and with a storage unit. In the latter case, it is fitted with a mechanism that allows the bedspring to be raised to two positions, 45° or horizontally. The interior is customised with removable panels and handles in hide, and is fully upholstered.

DE Bombosoft ist ein Polsterbett mit weichem und einladendem Kopfteil. Die großzügige Polsterung und die anschmiegsame Rückenlehne suggerieren auf den ersten Blick Entspannung und Wohlgefühl. Die Liebe zum Detail erinnert an hohe Schneiderkunst. Bombosoft steht sowohl in der Version Sommier als auch mit Bettkasten zu Auswahl. Im letzteren Fall ist das Bett mit einem Mechanismus

ausgestattet, der ein Anheben des Lattenrosts in zwei Positionen, 45° oder waagrecht, ermöglicht. Der Innenraum ist hingegen mit abnehmbaren Platten und Ledergriffen ausgestattet und vollständig bezogen.

ES Bombosoft es una cama tapizada, con un cabecero de estética suave y acogedora. Sus generosas tapicerías y su suave trasera evocan una idea de relax y confort, incluso visualmente. Se distingue por el cuidado sartorial de los detalles. Bombosoft está disponible en versión turca y con canapé. En este último caso está dotada de un mecanismo que permite elevar el somier en dos posiciones, a 45° u horizontalmente, mientras que el interior está personalizado con paneles desmontables y asas de cuero y revestido completamente.

FR Bombosoft est un lit rembourré avec une tête de lit à la forme moelleuse et accueillante. Les rembourrages généreux et le dossier moelleux suggèrent, même visuellement, une idée de détente et de confort. Le soin accordé aux détails est quasiment artisanal. Bombosoft existe tant en version sommier tapissier qu'avec coffre. Dans ce deuxième cas, il est doté d'un mécanisme qui permet de relever le sommier sur deux positions, avec ouverture à 45° ou bien en position horizontale, alors que l'intérieur du coffre est personnalisé avec des panneaux amovibles et des poignées en cuir et est entièrement revêtu en tissu.



Type
H 88 cm
H 34_{5/8}"

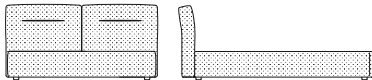

On floor

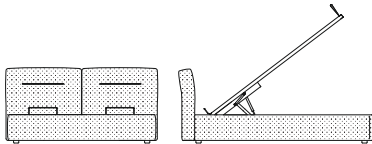

With storage, lifting 45°

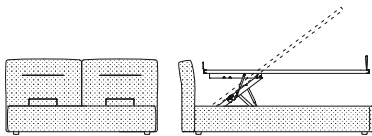

With storage, lifting 45°+ horizontal

For mattresses

L 150 P 200 cm L 160 P 200 cm L 183 P 203 cm
W 59" D 78_{5/8}" W 63" D 78_{5/8}" W 74_{5/8}" D 79_{7/8}"

L 153 P 203 cm L 170 P 200 cm L 190 P 200 cm
W 60_{2/8}" D 79_{7/8}" W 66_{7/8}" D 78_{5/8}" W 74_{5/8}" D 78_{5/8}"

L 160 P 190 cm L 180 P 200 cm L 193 P 203 cm
W 63" D 74_{5/8}" W 70_{7/8}" D 78_{5/8}" W 76" D 79_{7/8}"





Avenue Night night stand
Matt lacquer

Clapis bed
Upholstered in Divina Melange 3 fabric

Avenue Night





1



2



Avenue Night drawer unit
Matt lacquer

Novel Mirror
Matt lacquer, Mirror



1



Night stand for Avenue Boiserie



3

Avenue Night

DESIGN BY RUGA.PERISSINOTTO & SCIUTO ARCHITETTI, 2022

IT Avenue è un sistema trasversale che offre una libertà di progettazione senza precedenti. Pensato per il living contemporaneo si estende anche alla zona notte, dove può essere interpretato come comodino o come cassetiera. Negli elementi di Avenue Night, disponibili sia sospesi sia in appoggio a terra con zoccolino, l'elemento distintivo è il vano aperto, utile sia per aprire comodamente il cassetto sia come spazio di contenimento. Avenue Night si integra con Avenue Boiserie, per creare composizioni retroletto personalizzate.

EN Avenue is a versatile system that offers unprecedented scope in design. Designed for contemporary living, it can also be used in the sleeping area as a night stand or as a drawer unit. Avenue Night units, available in a wall-hung version or floor-standing with a plinth, have an open compartment that is the distinctive element. It is useful for conveniently opening the drawer and as storage space. Avenue Night can be combined with Avenue Boiserie to create customised back-to-wall compositions.

DE Avenue ist ein raumübergreifendes System, das eine bisher unerreichte Gestaltungsfreiheit schenkt. Für das zeitgemäße Wohnen konzipiert, kann es auch im Schlafbereich als Nachttisch oder Schubladenelement eingesetzt werden. Das Erkennungszeichen der Elemente Avenue Night, die wandhängend oder

bodenstehend mit Sockel erhältlich sind, ist das offene Abteil, das sowohl zum bequemen Öffnen der Schublade als auch als Stauraum dient. Avenue Night kann mit Avenue Boiserie kombiniert werden, um individuelle Zusammenstellungen hinter dem Bett zu verwirklichen.

ES Avenue es un sistema transversal que ofrece una libertad de diseño sin precedentes. Pensado para el salón contemporáneo, ahora se extiende hasta el dormitorio, donde puede interpretarse como mesita de noche o como cajonera. En los elementos de Avenue Night, disponibles tanto suspendidos como apoyados en el suelo con zócalo, el elemento distintivo es el compartimento abierto, útil para abrir cómodamente el cajón o como espacio de almacenaje. Avenue Night se integra con Avenue Boiserie para crear composiciones personalizadas detrás de la cama.

FR Avenue est un système transversal qui offre une liberté d'agencement sans précédent. Créé pour le living contemporain, il peut s'utiliser jusque dans la chambre à coucher où il peut être interprété comme chevet ou comme élément à tiroirs. Sur les éléments Avenue Night, existant tant en version suspendue qu'à poser au sol avec socle, l'élément distinctif est la niche haute utile pour ouvrir le tiroir, mais aussi comme espace de rangement. Avenue Night s'associe à Avenue Boiserie afin de créer des compositions au dos du lit tout à fait personnalisées.

Sizes



Night stand on floor
L 45 P 46 H 38 cm
W 17^{5/8}" D 18^{1/8}" H 15"

L 60 P 46 H 38 cm
W 23^{5/8}" D 18^{1/8}" H 15"

L 90 P 46 H 38 cm
W 35^{3/8}" D 18^{1/8}" H 15"

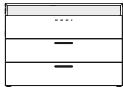

Drawer unit
L 120 P 54 H 86 cm
W 47^{2/8}" D 21^{2/8}" H 33^{7/8}"



Tall drawer unit
L 90 P 46 H 110 cm
W 35^{3/8}" D 18^{1/8}" H 43^{2/8}"



Suspended night stand/for boiserie
L 45 P 35 H 16 cm
W 17^{5/8}" D 13^{5/8}" H 6^{2/8}"

L 60 P 35 H 16 cm
W 23^{5/8}" D 13^{5/8}" H 6^{2/8}"



Suspended night stand/for boiserie
L 45 P 35 H 24 cm
W 17^{5/8}" D 13^{5/8}" H 9^{4/8}"

L 60 P 35 H 24 cm
W 23^{5/8}" D 13^{5/8}" H 9^{4/8}"



Multi use trays



Orbit night stand
Wood



1



2



1



2



Calacatta marble top

Orbit

DESIGN BY BLUEZONE, 2022

I Elegante e discreto, il comodino Orbit è caratterizzato dalla forma circolare. Poiché è un cilindro perfettamente rifinito, può essere usato anche staccato dalla parete, e perfino a centro stanza. La gola di apertura, integrata nei frontali del cassetto, ne mantiene la pulizia formale e garantisce la funzionalità. La scocca è in impiallacciato di frassino laccato o tinto, mentre il top può essere nella stessa finitura, oppure in prezioso marmo Calacatta o Nero Marquinia.

EN **Elegant and understated, the Orbit night stand features a rounded shape. As it is a perfectly finished cylinder, it can also be positioned detached from the wall, and even in the middle of a room. The grip recess opening, incorporated into the drawer fronts, maintains its formal simplicity and guarantees functionality. Its structure is in lacquered or stained ash veneer, whereas the top is available in the same finish, or in precious Calacatta or Black Marquinia marble.**

DE Der elegante und diskrete Nachttisch Orbit zeichnet sich durch seine runde Form aus. Da es sich um einen perfekt ausgefertigten Zylinder handelt, kann er auch mit Abstand zur Wand und sogar in der Raummitte verwendet werden. Die in die Schubladenfronten eingesetzte Hohlkehle bewahrt die formale Reinheit und sorgt für funktionellen Öffnungskomfort. Der Korpus ist mit lackiertem oder gebeiztem Eschenholz furnier beschichtet, die Abdeckplatte

ist in gleicher Ausführung oder aus wertvollem Marmor Calacatta oder Nero Marquinia erhältlich.

ES Elegante y discreta, la mesita de noche Orbit se caracteriza por su forma circular. Gracias al perfecto acabado de su estructura cilíndrica, puede colocarse lejos de la pared o incluso en el centro de la habitación. La gola de apertura integrada en el frente de los cajones preserva su limpieza formal garantizando su funcionalidad. El bastidor está chapado en fresno lacado o teñido, mientras que la encimera puede presentar el mismo acabado o estar realizada en un lujoso mármol Calacatta o Nero Marquinia.

FR À la fois élégant et discret, le chevet Orbit se distingue par une forme ronde. Puisqu'il s'agit d'un meuble cylindrique avec l'extérieur parfaitement fini, on pourra également l'installer loin d'un mur et même au milieu d'une pièce. La gorge utilisée pour l'ouverture et intégrée dans les façades des tiroirs assure une esthétique à la fois épurée et fonctionnelle. Le caisson est plaqué frêne, laqué ou teinté, alors que le plateau peut avoir soit la même finition soit être réalisé en marbre Calacatta ou Nero Marquinia.

Sizes



Ø 52 H 50 cm
Ø 20^{1/8}" H 19^{5/8}"







Novel Island
Melamine-faced

Novel closet
Lacquered metal, Matt lacquer

Integrated Telon curtain
Twilight fabric



1



2

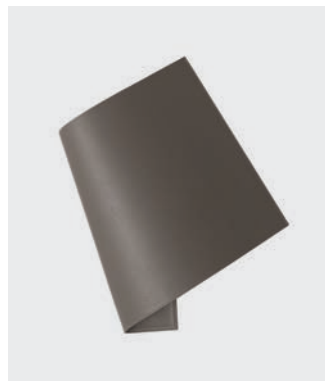

Faux leather mat



Multi-use trays

Novel Island

DESIGN BY RUGA.PERISSINOTTO, 2021

Novel Island è una cassetiera a isola progettata per completare l'area guardaroba. Perfettamente rifinita sui quattro lati, si usa al centro della cabina armadio o dello spazio dedicato agli armadi. Top trasparenti, vassoi portaoggetti e svuotatasche sono gli elementi che la rendono preziosa, così come la combinazione di materiali e superfici sofisticate. La minima sospensione da terra, le maniglie a filo della sporgenza dei fianchi, gli spessori ridotti e i giochi di trasparenze rendono le sue linee delicate, trasformando la cassetiera in un elemento dallo stile minimale e contemporaneo che mostra e contiene allo stesso tempo.

Novel Island is an island drawer unit designed to complement the wardrobe area. Perfectly finished on all four sides, it can be used in the centre of a walk-in wardrobe or wardrobe space. Transparent tops, accessory trays and tidy trays are the elements that make it precious, like the combination of sophisticated materials and surfaces. Minimal suspension from the floor, handles flush with projecting side panels, reduced thicknesses and transparent effects make its lines delicate, transforming the drawer unit into a minimalist and contemporary element that not only reveals but also keeps things tidy.

Novel Island ist ein zur Vervollständigung des Ankleidebereichs konzipierter freistehender Schubladenschrank. Er besitzt vier perfekt ausgefertigte Seiten und wird in der Mitte der

Schränkkabine oder an dem für Schränke vorgesehenen Platz eingesetzt. Transparente Abdeckplatten, Tablett und Ablageschalen machen ihn genauso hochwertig wie die Kombination aus edlen Materialien und Oberflächen. Die minimale Anhebung vom Boden, die zu den vorstehenden Seitenwänden flächenbündigen Griffe, die reduzierten Stärken und das Wechselspiel der transparenten Flächen sorgen für feine Linien und verwandeln den Schubladenschrank in ein Element mit minimalem und zeitgenössischem Stil, der seinen Inhalt gleichzeitig zur Schau stellt und verwahrt.

Novel Island es una cajonera independiente diseñada para completar el área del guardarropa. Perfectamente acabada en los cuatro lados, se utiliza en el centro del vestidor o del espacio dedicado a los armarios. Sus encimeras transparentes y sus bandejas portaobjetos y vaciabolillos le confieren un carácter exclusivo, así como la combinación de materiales y superficies sofisticadas. Ligeramente suspendida en el suelo, se distingue por sus tiradores al ras del saliente de los costados, sus reducidos espesores y sus juegos de transparencias, que aportan delicadeza a sus líneas transformando la cajonera en una pieza de estilo minimalista y contemporáneo, capaz de funcionar como elemento de exposición y de almacenaje al mismo tiempo.

Novel Island est un meuble à tiroirs en îlot conçu pour compléter la zone armoires/dressing.

Parfaitement fini sur les quatre côtés, il s'installe au milieu du dressing ou de l'espace destiné aux armoires. Les plateaux supérieurs transparents, les plateaux range-accessoires et les vide-poches sont les éléments qui enrichissent son aspect tout comme la combinaison des matériaux et des finitions recherchées. La suspension minimale du sol, les poignées à fleur des côtés, les épaisseurs réduites et les jeux de transparence adoucissent les lignes délicates de ce meuble à tiroirs et le transforment en un élément au style minimaliste et contemporain servant à la fois à montrer et à ranger.

Sizes

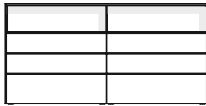

L 152 P 109 H 96 cm
W 59^{7/8}" D 42^{7/8}" H 37^{6/8}"

L 172 P 109 H 96 cm
W 67^{6/8}" D 42^{7/8}" H 37^{6/8}"

L 192 P 109 H 96 cm
W 75^{5/8}" D 42^{7/8}" H 37^{6/8}"

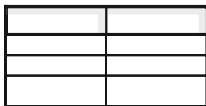
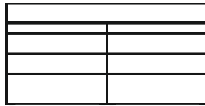

L 152 P 96,5 H 96 cm
W 59^{7/8}" D 38" H 37^{6/8}"

L 172 P 96,5 H 96 cm
W 67^{6/8}" D 38" H 37^{6/8}"

L 192 P 96,5 H 96 cm
W 75^{5/8}" D 38" H 37^{6/8}"

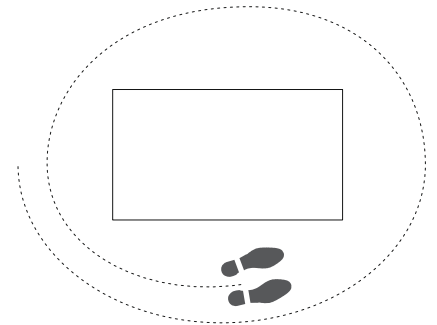



Avenue Boiserie
Wood, Matt lacquer, Mirror, Lacquered metal

Tag bedside table
Laminate top

Bela armchair
Upholstered in Moss fabric

Telon curtain
Zulu 2 fabric

Avenue Boiserie



Bombosoft bed
Upholstered in Parigi fabric



Avenue Boiserie
Verso fabric, Wood

Clapis sommier bed
Upholstered in Verso fabric

Tag bedside table
Laminate top



Avenue Night night stand
Matt lacquer



Night stand for Avenue Boiserie



Led lights are dimmable with touch control





1



Hook

Horizontal boiserie panel (* = Upholstered)

59,7 - 89,7 - 119,7 - 149,7 - 179,7 - 209,7 - 239,7 - 269,7 - 299,7 cm
 23 4/8" - 35 3/8" - 47 1/8" - 58 7/8" - 70 5/8" - 82 1/8" - 94 3/8" - 106 1/8" - 118"

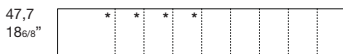
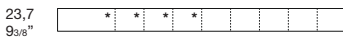
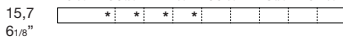

Horizontal boiserie panel near bases (* = Upholstered)

59,7 - 89,7 - 119,7 - 149,7 - 179,7 - 209,7 - 239,7 - 269,7 - 299,7 cm
 23 4/8" - 35 3/8" - 47 1/8" - 58 7/8" - 70 5/8" - 82 1/8" - 94 3/8" - 106 1/8" - 118"

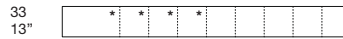
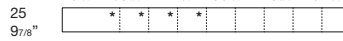

Vertical boiserie panel (* = Upholstered ** = Cork, Mirror)

30 60
11 5/8" 23 5/8"

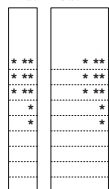

H 64 - 80 - 96 - 112 - 128 - 144 - 160 - 176 - 192 cm
 H 25 1/2" - 31 1/8" - 37 5/8" - 44 1/8" - 50 3/8" - 56 5/8" - 63" - 69 1/8" - 75 5/8"

Metal shelves for Boiserie P 24 cm D 9 1/8"

43,8 58,8 88,8
 17 1/8" 23 1/8" 35"
 0,25
 1/8"

Hook and knob for Boiserie



Avenue Boiserie

DESIGN BY RUGA.PERISSINOTTO & SCIUTO ARCHITETTI, 2021

IT Nato per il living, il sistema Avenue Boiserie si presta anche alle necessità della zona notte. Il sistema, composto da un retro-pannello preforato a cui si applicano pannelli estetici e accessori, può essere dotato di luce a LED perimetrale, dimmerabile e con accensione integrata. La ricchezza degli elementi ne rispecchia la versatilità: alla boiserie si applicano infatti mensole metalliche di spessore ridotto, pensili e basi, pannelli in tessuto, specchio o sughero e appendiabiti.

EN Created for the living room, the Avenue Boiserie system also lends itself to the needs of the sleeping area. The system, consisting of a pre-drilled back-panel, to which aesthetic panels and accessories can be attached, can be fitted with a perimeter, dimmable LED light with integrated switch-on. The wealth of elements reflects its versatility: reduced thickness metal shelves, wall and base units, fabric panels, a mirror or cork panels and clothes hooks can be attached to the boiserie.

DE Das für den Wohnraum konzipierte System Boiserie eignet sich auch für die Bedürfnisse des Schlafbereichs. Das System besteht aus einer vorgebohrten Rückwandplatte, auf der Dekor-Paneele und Zubehörteile angebracht werden und lässt sich mit einer umlaufenden dimmbaren LED-Beleuchtung mit integriertem Einschaltmodul ausstatten. Die Fülle der Elemente spiegelt die Vielseitigkeit wider: An der Boiserie können Regalböden aus Metall mit

reduzierter Stärke, Ober- und Unterschränke, Stoff-, Spiegel- oder Korkpaneele sowie Kleiderhaken angebracht werden.

ES Nacido para el salón, el sistema Avenue Boiserie también es perfecto para satisfacer las necesidades del dormitorio. Compuesto por un panel trasero perforado sobre el que se aplican paneles de acabado y accesorios, el sistema puede estar dotado de luz LED perimétrica, regulable y con encendido integrado. La riqueza de los elementos refleja su versatilidad: la boiserie se utiliza para aplicar estantes metálicos de espesor reducido, colgantes y muebles bajos, paneles de tejido, espejo o corcho y colgadores.

FR Créé pour le living, le système Avenue Boiserie convient également aux besoins d'une chambre à coucher. Ce système se compose d'un panneau arrière pré-perforé auquel il est possible de fixer des panneaux de finition et des accessoires et dont le pourtour peut être équipé d'un éclairage à leds dimmable et avec allumage intégré. La richesse des éléments proposés en reflète la polyvalence: en effet, il est possible de fixer à cet habillage mural, des étagères métalliques très fines, des éléments hauts et des éléments bas, des panneaux en tissu, un miroir ou un panneau en liège et des patères.

Base units suspended for Boiserie P 50 cm D 19 $\frac{5}{8}$ "



Metal trays P 50 cm D 19 $\frac{5}{8}$ "

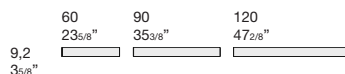

Top for base units P 50 cm D 19 $\frac{5}{8}$ "

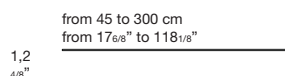

Top for base units/Folder edge shelf P 50 cm D 19 $\frac{5}{8}$ "

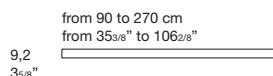

Wall units for Boiserie P 35 cm D 13 $\frac{6}{8}$ "

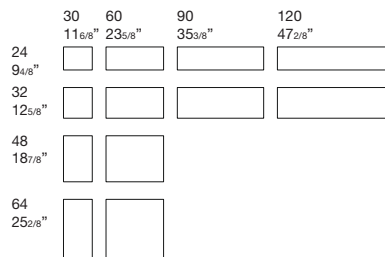

Wall units for Boiserie, 1 open side P 35 cm D 13 $\frac{6}{8}$ "

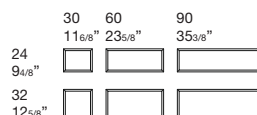

Metal wall units for Boiserie, 1 open side P 35 cm D 13 $\frac{6}{8}$ "



Avenue Night stand for Boiserie

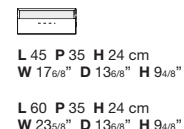
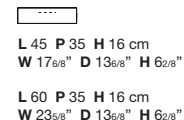



Bela	186
Flap	194
Librio	204
Tag	200
Valet	180



Valet armchair
Upholstered in Moss fabric

Legri bed
Upholstered in Moss fabric

Telon curtain
Twilight fabric

Valet



Valet handle
Lacquered metal





Valet armchair
Upholstered in Moss fabric

Telon curtain
Twilight fabric



1



Valet handle

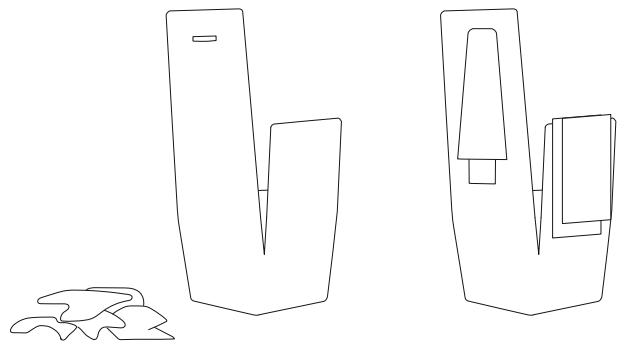

Valet

DESIGN BY ALBERTO LIEVORE, 2021

IT Come un assistente che sorveglia il nostro riposo e semplifica la nostra vita, Valet è un oggetto trasversale, al contempo sedia, poltroncina, pouf, servomuto e appendino. Le linee sono morbide e curve, eppure slanciate; le dimensioni ridotte. L'estetica ricercata è ispirata a una tesa morbidezza che accoglie e sostiene in modo discreto ed elegante. Lo schienale alto da un lato funge da servomuto, così come il bracciolo singolo, dall'altro offre un ottimo supporto lombare e cervicale consentendo di poggiare comodamente il capo. I piedini, scuri e rientranti, ne sottolineano la leggerezza visiva, facendo sembrare Valet quasi sospesa da terra.

EN Like an assistant that monitors our rest and simplifies our lives, Valet is a versatile object as well as a chair, armchair, pouf, valet stand and clothes hanger. It features soft and curved, yet sleek lines; with small dimensions. The refined aesthetics are inspired by a taut softness that accommodates and supports in an understated and elegant manner. The high backrest, on the one hand, can be used as a valet stand, whereas the single armrest, on the other, provides excellent support for the lower back and neck, allowing your head to rest comfortably. Its dark, recessed feet enhance its visual lightness, making Valet seem almost suspended above the floor.

DE Wie ein persönlicher Assistent, der über unsere Erholung wacht und unser Leben vereinfacht, ist

Valet ein wandlungsfähiges Objekt, das gleichzeitig Stuhl, Sessel, Pouf, stummer Diener und Kleiderständer ist. Die Linien sind weich und gerundet, aber dennoch schlank, die Maße zurückhaltend. Die raffinierte Ästhetik wird von einer straffen Weichheit inspiriert, die auf diskrete und elegante Weise einhüllt und stützt. Die hohe Rückenlehne fungiert wie auch die einzelne Armlehne einerseits als stummer Diener, bietet andererseits eine hervorragende Lenden- und Nackenstütze, um den Kopf bequem anzulehnen. Die dunklen, zurückversetzten Füße betonen die visuelle Leichtigkeit, dank der Valet fast über dem Boden zu schweben scheint.

ES Como un asistente que vigila nuestro descanso y simplifica nuestra vida, Valet es un objeto transversal: silla, butaca, puf, galán de noche y colgador al mismo tiempo. Sus líneas son suaves y curvas, pero también estilizadas; sus dimensiones reducidas. Su estética sofisticada evoca una tensa suavidad dando vida a un soporte acogedor, elegante y discreto. El respaldo alto funciona como galán de noche por un lado, al igual que el brazo único, y ofrece un excelente soporte lumbar y cervical por el otro, permitiendo apoyar cómodamente la cabeza. Las patas oscuras y entrantes de Valet resaltan su ligereza visual haciendo que parezca casi suspendida sobre el suelo.

FR Comme un assistant qui surveille notre repos et qui simplifie notre vie, Valet est un objet transversal faisant office de chaise, de fauteuil,

de pouf, de valet de chambre et de porte-vêtements. Bien qu'élancées, les lignes sont douces et arrondies, les dimensions sont compactes. L'esthétique recherchée s'inspire d'une douceur tendue qui accueille et qui soutient de façon discrète et élégante. Le dossier haut, tout comme l'accoudoir, fait non seulement office de valet de chambre, mais il peut également offrir un excellent support lombaire et cervical puisqu'il permet de soutenir confortablement la tête. Les pieds foncés et rentrants en soulignent la légèreté visuelle puisqu'ils donnent l'impression que Valet est en suspension.

Type

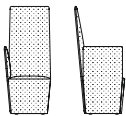

Lh
L 55 P 61 H 120 cm
W 21_{5/8}" D 24" H 47_{2/8}"

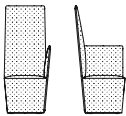

Rh
L 55 P 61 H 120 cm
W 21_{5/8}" D 24" H 47_{2/8}"



image © Alberto Lievore



Bela armchair
Upholstered in Elimosoft leather

Librio occasional table
Laminate top

Bela







Bela armchair
Upholstered in Elmosoft leather



Bela armchair
Upholstered in Elmosoft leather



Bela armchair
Upholstered in Moss fabric

Avenue Boiserie
Wood, Mirror, Lacquered metal

Novel Island
Melamine-faced



1

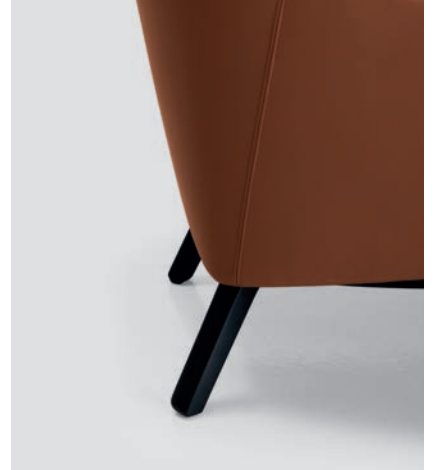

2



3

Bela

DESIGN BY LÄUFER & KEICHEL, 2022

Il duo di designer Läufer&Keichel mette a punto una poltroncina dalle linee morbide e accoglienti, ideale nella zona living ma anche in camera da letto, sia da sola sia in coppia. Bela è caratterizzata da una seduta profonda e generosa imbottita in poliuretano espanso, mentre il comfort è amplificato dalle cinghie elastiche. La cura sartoriale del rivestimento valorizza la curva dello schienale avvolgente, che si allunga a creare i braccioli. Elegante il basamento, in legno massello di frassino, sagomato intorno alla seduta per una perfetta integrazione.

The designer duo Läufer&Keichel have developed a small armchair with soft enveloping contours. It's ideal in the living area and in the bedroom, either on its own or as a pair. Bela features a deep and generous seat padded with polyurethane foam, whereas comfort is increased with elastic straps. The tailored craftsmanship of the upholstery enhances the curve of the enveloping backrest, which extends to create the armrests. The elegant base support is made of solid ash wood, shaped around the seat for perfect integration.

Das Designerduo Läufer&Keichel hat einen kleinen Sessel mit weichen und einladenden Linien entworfen, der allein oder zu zweit ideal in den Wohnbereich, aber auch ins Schlafzimmer passt. Bela zeichnet sich durch eine tiefe, großzügige und mit PUR-Schaumstoff

gepolsterte Sitzfläche aus, der Komfort wird hingegen durch elastische Gurte verstärkt. Der nach bester Schneiderkunst verarbeitete Bezug hebt die Rundung der anschmiegsamen Rückenlehne hervor, die in Armlehnen übergeht. Elegant ist auch das Untergestell aus massivem Eschenholz, dessen abgerundete Form die Sitzfläche auf harmonische Weise umschließt.

El dúo de diseñadores Läufer&Keichel ha desarrollado una butaca de líneas suaves y acogedoras ideal para el salón o para el dormitorio, tanto sola como en pareja. Bela se caracteriza por su asiento amplio y profundo tapizado con espuma de poliuretano y por sus correas elásticas, que aseguran el máximo confort. La minuciosidad sartorial del revestimiento resalta la curva del respaldo envolvente, que se extiende creando los brazos. Su elegante base está realizada en madera maciza de fresno perfilada alrededor del asiento para asegurar su perfecta integración.

Le duo de designers Läufer&Keichel met au point un fauteuil aux lignes douces et accueillantes, parfait pour le living, mais aussi pour la chambre à coucher, et cela qu'il soit utilisé individuellement ou par deux. Bela se distingue par une assise profonde et généreuse, garnie en polyuréthane expansé, alors que les sangles élastiques en augmentent le confort. Le soin, quasiment artisanal, accordé au revêtement valorise la courbe du dossier enveloppant qui s'allonge pour créer les

accoudoirs. Le piètement en frêne massif est élégant et cerne l'assise galbée à laquelle il s'intègre parfaitement.

Type

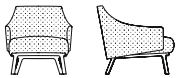

L 72 P 81 H 75 cm
W 28^{3/8}" D 31^{7/8}" H 29^{4/8}"

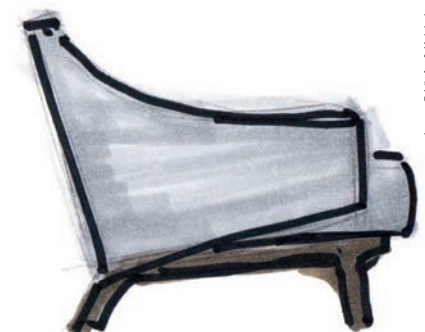
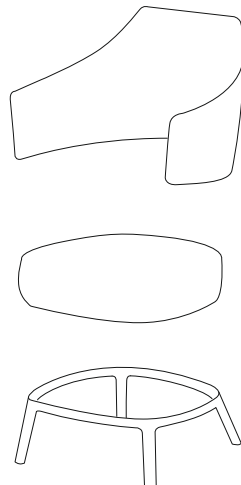



Flap armchair
Upholstered in Divina Melange 3 fabric

Flap





Flap armchair
Upholstered in Divina Melange 3 fabric



Flap armchair
Upholstered in Divina Melange 3 fabric



1

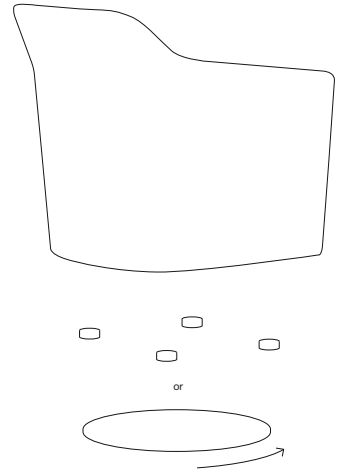

2

Flap

DESIGN BY RAMOS BASSOLS, 2022

IT Lo studio Ramos-Bassols disegna una poltrona dalle linee dinamiche, ispirata ai flap degli aerei. La forma è il risultato dell'ipotetica sovrapposizione di una seduta sottile e un volume massiccio, ed esprime un sapiente equilibrio tra spessori e curve concave e convesse. Se la struttura in multistrato guarda al mondo nautico, il rivestimento è invece ispirato alla sartorialità. Confortevole anche visivamente, Flap è progettata per accogliere il corpo con imbottiture di diversa densità. Disponibile con piedini o con disco girevole con meccanismo di ritorno, ha dimensioni contenute che la rendono adatta a ogni ambiente, domestico o contract.

EN **The Ramos&Bassols studio has designed an armchair with dynamic lines inspired by aircraft flaps. The shape is the outcome of the hypothetical superimposition of a slender seat and a large volume. It conveys a skilful balance of thicknesses and concave and convex curves. While the plywood structure recalls the nautical world, the upholstery is inspired by tailoring. Also visually comfortable, Flap is designed to accommodate the body with padding of different densities. Available with feet or a swivel disc-return mechanism, it's dimensions are small, making it ideal for any home or contract environment.**

DE Das Studio Ramos-Bassols hat einen Sessel mit dynamischer Linienführung entworfen, der von den Landeklappen der Flugzeuge inspiriert

ist. Die Form ist das Ergebnis der hypothetischen Überlagerung einer dünnen Sitzfläche und eines massiven Volumens und bringt ein geschicktes Gleichgewicht zwischen den Stärken und den konkaven und konvexen Kurven zum Ausdruck. Wenn die Struktur aus Mehrschichtenholz an die Schifffahrt erinnert, dann ist der Bezug ein Beispiel hoher Schneiderkunst. Der auch optisch ansprechende Sessel Flap passt sich dem Körper mit einer Polsterung in unterschiedlichen Stärken an. Er ist mit Füßen oder einem Drehteller mit Rücklaufmechanismus erhältlich und eignet sich dank seiner kompakten Maße sowohl für Wohnräume als auch für die Contract-Branche.

ES El estudio Ramos-Bassols diseña una butaca de líneas dinámicas, inspirada en los alerones de los aviones. Su forma es el resultado de la hipotética superposición de un asiento fino y un volumen macizo y expresa un sabio equilibrio entre sus distintos espesores y sus curvas cóncavas y convexas. La estructura en multicapa evoca el mundo náutico, mientras que el revestimiento se inspira en el mundo de la alta costura. Confortable también visualmente, Flap ha sido proyectada para acoger el cuerpo con acolchados de densidad diferenciada. Está disponible con patas o con un disco giratorio con mecanismo de retorno y, gracias a sus reducidas dimensiones, se adapta a cualquier ambiente doméstico o colectivo.

FR L'agence Ramos-Bassols dessine un fauteuil aux lignes dynamiques, s'inspirant des volets

des avions. Sa forme est le résultat de la superposition hypothétique d'une assise fine et d'un volume massif et exprime un savant équilibre entre les épaisseurs et les courbes concaves et convexes. Si la structure en multiplis se tourne vers le monde nautique, le revêtement en revanche s'inspire de l'artisanat. Confortable même visuellement, Flap a été conçu pour accueillir le corps avec des rembourrages de différente densité. Existant avec pieds ou avec embase ronde pivotante avec mécanisme de retour, il a de petites dimensions qui permettent de l'installer n'importe où, aussi bien chez le particulier que dans les espaces publics.

Type

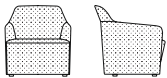

Fixed
L 72 P 77 H 77 cm
W 28^{3/8}" D 30^{3/8}" H 30^{3/8}"

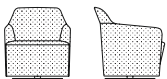

With swivel mechanism
L 72 P 77 H 78 cm
W 28^{3/8}" D 30^{3/8}" H 30^{6/8}"

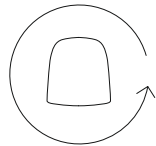



Tag bedside table
Laminate top

Clapis bed
Upholstered in Borgo fabric



Tag occasional table
Laminate/wood tops



Under-top drawer



2



3

Tag

DESIGN BY ALTHERR DÉSILE PARK, 2021

I Tag è una collezione di tavolini di diverse dimensioni, con piano tondo o quadrato. Il profilo essenziale rende il loro aspetto leggero e l'estetica fluida, ideale sia nella zona giorno sia nella zona notte. Accanto al letto, Tag si interpreta come comodino, soprattutto nella versione con cassetto sottopiano, mentre nel living è un comodo tavolino da posizionare accanto al divano. La base a fusto, con piede circolare o quadrato, si abbina al top in essenza o in Fenix, una superficie elegantemente opaca, anti-impronta e morbida al tocco.

EN Tag is a collection of low tables in various dimensions, with a round or square top. The minimalist profile makes them light with a fluid aesthetic look, ideal for the living area and the sleeping area. Next to a bed, Tag becomes a bedside table, especially in the version with an under-top drawer, whereas in the living room it becomes a practical low table to place next to the sofa. The column base, with round or square feet, is combined with a wood veneer or Fenix top, an elegantly matt, anti-fingerprint surface that is soft to the touch.

DE Tag ist eine Kollektion von Beistelltischen in verschiedenen Größen und mit runder oder quadratischer Platte. Das essenzielle Profil schenkt ihnen ein schwereloses Aussehen und eine geschmeidige Ästhetik, wodurch sie im Wohn- und Schlafbereich eine gleichermaßen gute Figur machen. Neben dem Bett wird Tag vor

allem in der Version mit Schublade zum Nachttisch, im Wohnzimmer ist er hingegen ein bequemer Beistelltisch, der gut neben das Sofa passt. Die säulenförmige Basis mit rundem oder quadratischem Fuß wird mit einer Platte aus Holz oder aus Fenix kombiniert, einer eleganten, matten, fingerabdruckresistenten Oberfläche, die sich angenehm weich anfühlt.

ES Tag es una colección de mesitas de distintos tamaños, con sobre redondo o cuadrado. Su perfil esencial produce un efecto estético ligero y fluido, ideal tanto en la sala de estar como en los dormitorios. Junto a la cama, Tag juega el papel de mesita de noche, sobre todo en la versión provista de cajón debajo de la encimera, mientras que en el salón se transforma en una cómoda mesita auxiliar para colocar junto al sofá. La base con columna, con pie circular o cuadrado, se puede combinar con un sobre de madera o de Fenix: una elegante superficie mate, antihuellas y suave al tacto.

FR Tag est une collection de tables basses de différentes dimensions, avec plateau rond ou carré. Grâce à leur forme épurée, elles ont un aspect léger et une esthétique fluide et sont parfaites tant pour le séjour que la chambre à coucher. Près d'un lit, Tag fait office de chevet, notamment la version avec tiroir sous plan, alors que dans le living, elle devient une pratique table d'appoint à installer près du canapé. Le pied en métal, se terminant par une embase ronde ou carrée, s'associe à un plateau en bois

ou bien en Fenix, une surface élégante mate, anti-traces de doigt et douce au toucher.

Sizes



Ø 45 H 50-55-65 cm
Ø 17^{5/8}" H 19^{5/8}-21^{5/8}-25^{5/8}"

Ø 55 H 50-55-65 cm
Ø 21^{5/8}" H 19^{5/8}-21^{5/8}-25^{5/8}"



L 45x45 H 55 cm
W 17^{5/8}x17^{5/8}" H 21^{5/8}"



L 45x45 H 50-55-65 cm
W 17^{5/8}x17^{5/8}" H 19^{5/8}-21^{5/8}-25^{5/8}"

L 55x55 H 50-55-65 cm
W 21^{5/8}x21^{5/8}" H 19^{5/8}-21^{5/8}-25^{5/8}"



Librio occasional table
Laminate top

Telon curtain
Lino Lino fabric

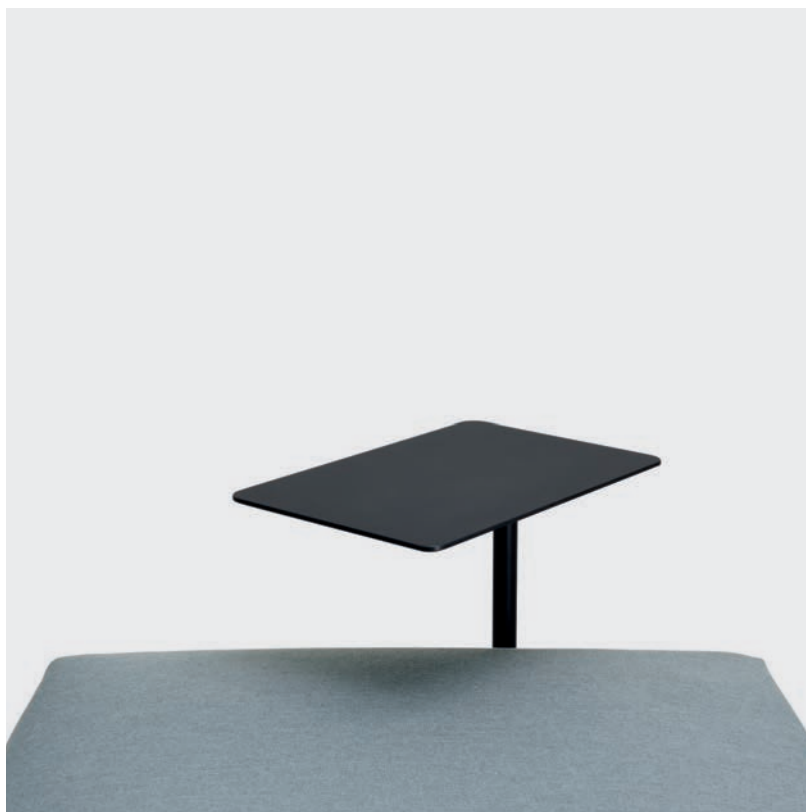

Librio occasional table
Laminate top



1

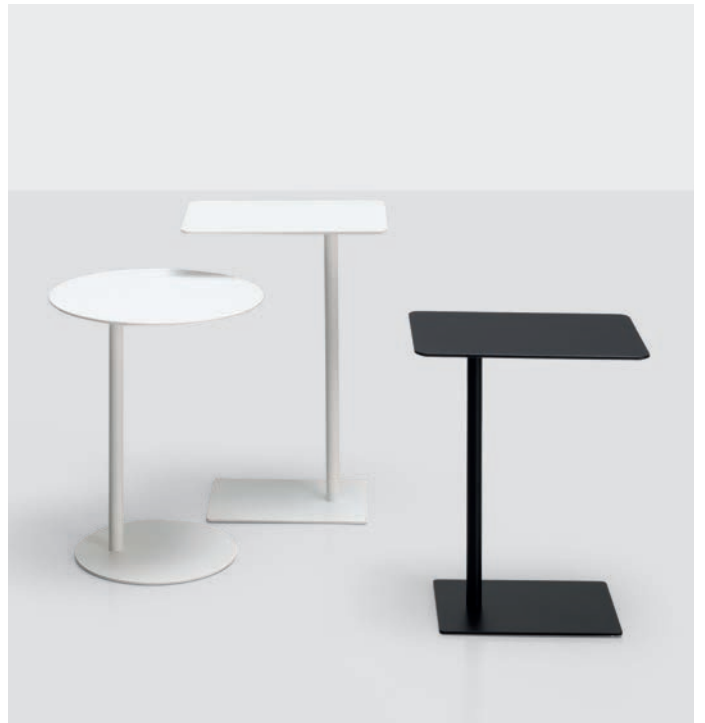

2

Librio

DESIGN BY BLUEZONE, 2022

IT Libro è una collezione di tavolini la cui particolarità è che il piano, rettangolare o tondo, è posto in equilibrio su un fusto sottile, asimmetrico rispetto al centro. L'estetica essenziale ne fa un complemento fluido, ideale sia come tavolino di servizio accanto al divano o a una poltrona sia come comodino vicino al letto. La base in metallo verniciato si abbina al top in essenza o in Fenix, una superficie elegantemente opaca, anti-impronta e morbida al tatto.

EN Libro is a collection of low tables with a rectangular or round top as the distinctive feature. It rests on a slender column that is offset from the centre. Its essential aesthetic appeal make it a fluid furnishing accessory, ideal as a side table next to a sofa or armchair, or as a bedside table. The painted metal base is combined with a wood veneer or Fenix top, an elegantly matt, anti-fingerprint surface that is soft to the touch.

DE Libro ist eine Kollektion von Beistelltischen, die sich dadurch hervorhebt, dass die rechteckige oder runde Platte auf einer schlanken, asymmetrisch zur Mitte angebrachten Säule ruht. Die essentielle Ästhetik macht ihn zu einem vielseitigen Element, ideal als Ablagetisch neben dem Sofa oder einem Sessel oder als Nachttisch in der Nähe des Betts. Die Basis aus lackiertem Metall wird mit einer Platte aus Holz oder aus Fenix kombiniert, einer eleganten, matten, fingerabdruckresistenten Oberfläche, die sich angenehm weich anfühlt.

Sizes

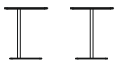

Ø 45 H 50-55-65 cm
Ø 17^{5/8}" H 19^{5/8}-21^{5/8}-25^{5/8}"

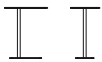

L 45x30 H 50-55-65 cm
W 17^{5/8}x11^{5/8}" H 19^{5/8}-21^{5/8}-25^{5/8}"

ES Libro es una colección de mesitas cuya peculiaridad reside en la posición del sobre rectangular o redondo: en equilibrio sobre una fina columna y asimétrica respecto al centro. Su estética esencial las convierte en un complemento sumamente versátil, ideal como mesita de servicio al lado del sofá o de una butaca o como mesita de noche junto a la cama. La base de metal barnizado se puede combinar con un sobre de madera o de Fenix: una elegante superficie mate, antihuellas y suave al tacto.

FR Libro est une collection de tables basses qui ont la particularité d'avoir le plateau, rond ou rectangulaire, en équilibre sur un pied fin installé en position asymétrique. Leur esthétique épurée les transforme en un complément d'ameublement fluide, parfait tant comme table d'appoint à côté d'un canapé que comme chevet près d'un lit. Le piètement en métal laqué s'associe à un plateau en bois ou en Fenix, une surface élégante mate, anti-traces de doigt et douce au toucher.



1



2

