







**/ RE.AC**



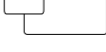

|   |  |            |
|---|--|------------|
|    | <b>LUX</b>   | <b>5</b>   |
|    | <b>OUTLINE</b>   | <b>19</b>  |
|    | <b>FARM</b>  | <b>35</b>  |
|    | <b>DOMOMAG</b>   | <b>47</b>  |
|    | <b>KUBICK</b>  | <b>59</b>  |
|  | <b>B-SOUND</b>   | <b>75</b>  |
|  | <b>COMPLEMENTI</b><br>complements<br>compléments<br>Ergänzungen<br>complementos  | <b>85</b>  |
|  | <b>ACCESSORI</b><br>accessories<br>accessories<br>Zubehör<br>accessorios   | <b>105</b> |
|   | <b>finiture e colori</b><br>finishing and colors<br>finitions et couleurs<br>Oberfläche und farben<br>acabados y colores | <b>127</b> |

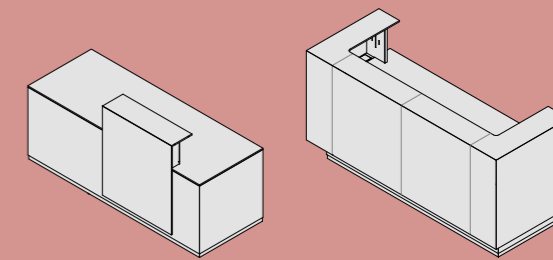

## LUX

*design:*  
Gianantonio Perin  
Monica Fernandes

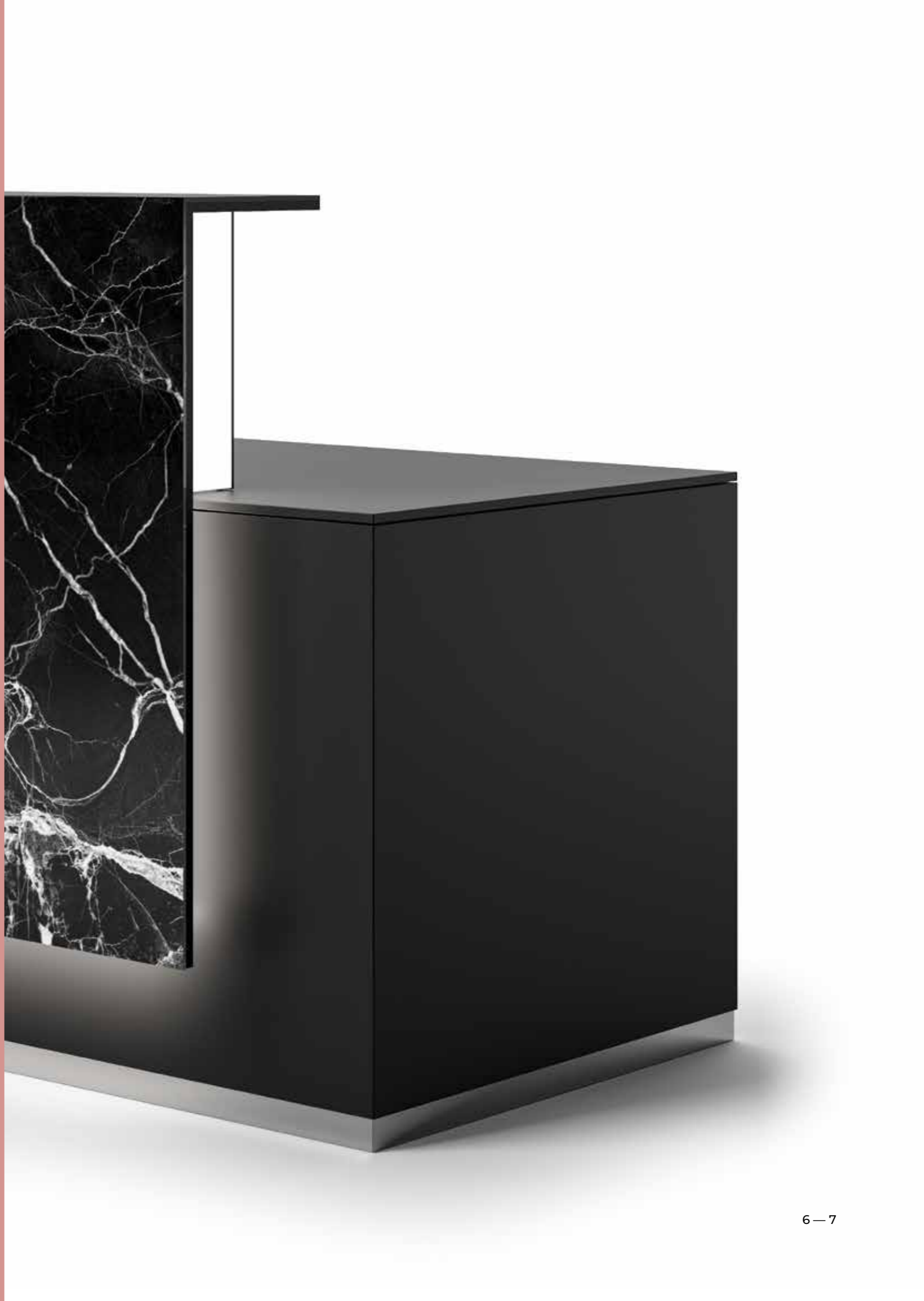













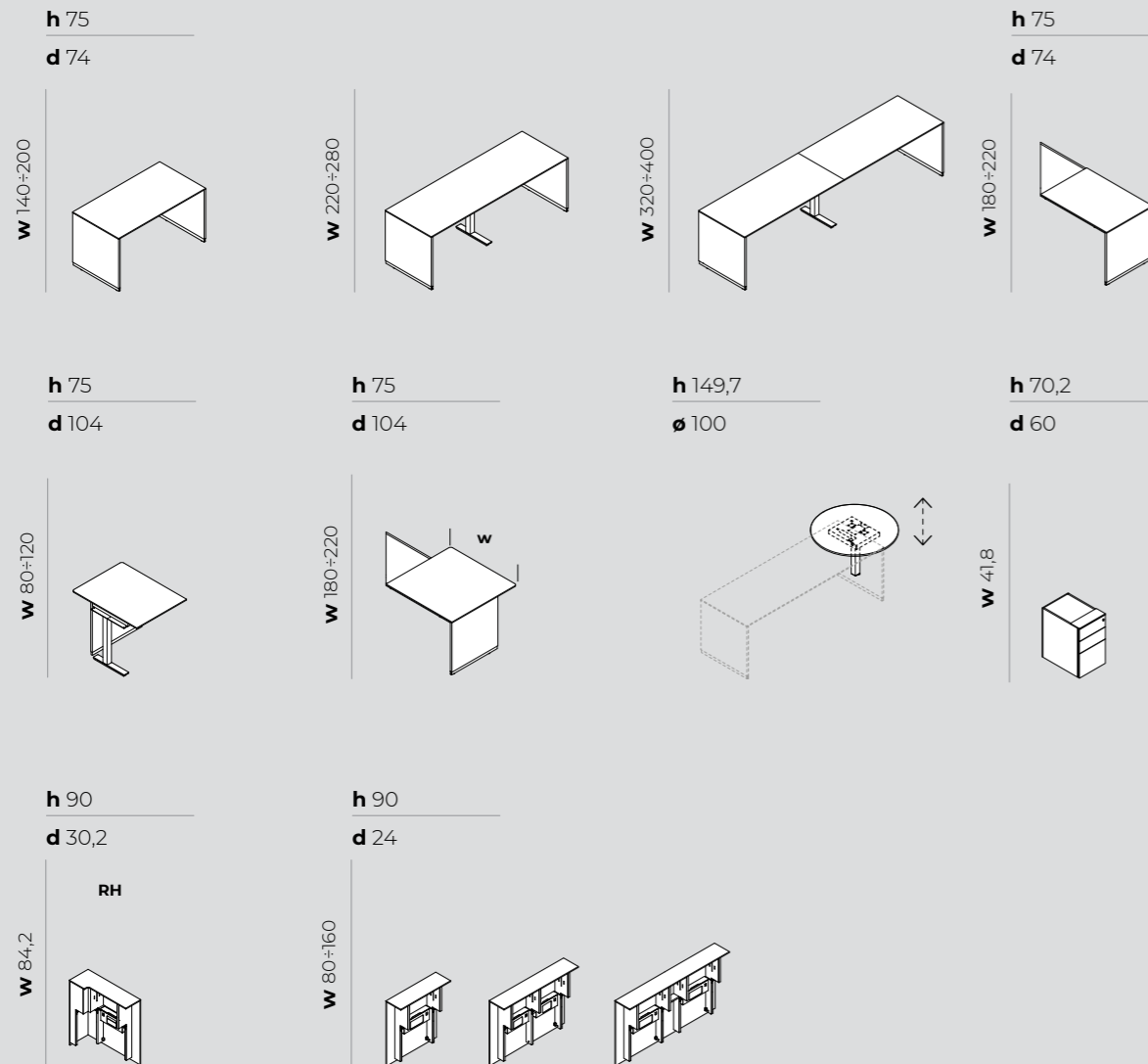

measure in cm • measurements in cm • mesures en cm • Maße in cm • medidas en cm



**bancone**  
counter  
comptoir  
Stheke  
contador

**melaminico**, melamine, mélamine,  
melamin, melamina



**vaschetta passacavi**  
top access  
chemin de câbles  
Kabelwanne  
bandeja de cables



**mensola**  
shelf  
étagère  
Regal  
repisa

**luci led**  
LED lights  
lumières LED  
LED-unterbauleuchten  
lucos led

**zoccolo**  
skirting  
socle  
Sockel  
zócalo

**gamba intermedia**  
mid leg  
ped intermédiaire  
Zwischenbein  
pata intermedia

**metallo**, metal, métal,  
metal, metal



### highlights

**cassettiera portante**  
desk height pedestal  
caissons portant  
Standcontainer  
cajón de sustentación



**cassetino portafogli**  
paper tray  
 tiroir porte documents  
Brieftaschenschublade  
cajón pequeño para hojas

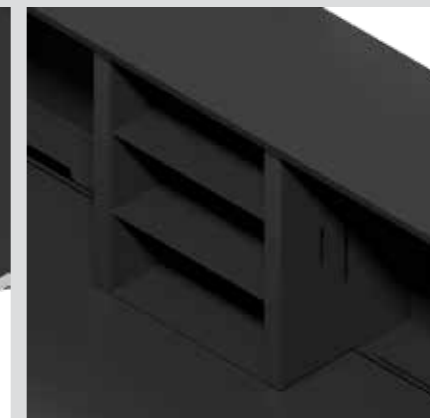

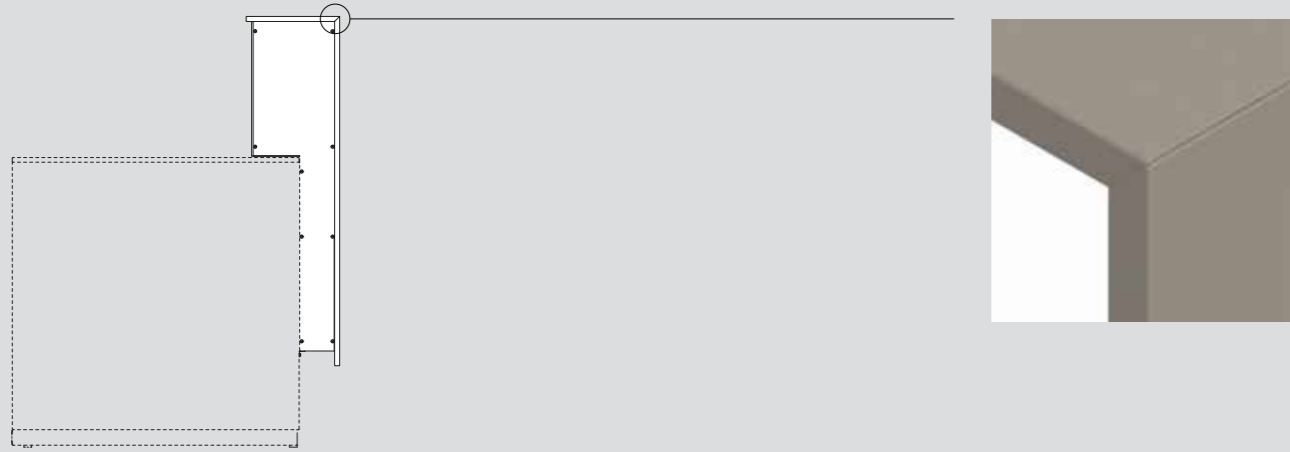

**melaminico**

melamine  
mélamine  
melamin  
melamina



**legno**

veneer  
bois  
holz  
madera

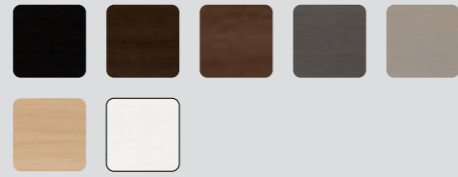

**vetro stampato**  
printed glass  
verre imprimé  
Bedrucktes Glas  
vidrio impreso



**melaminico**  
melamine  
mélamine  
melamin  
melamina

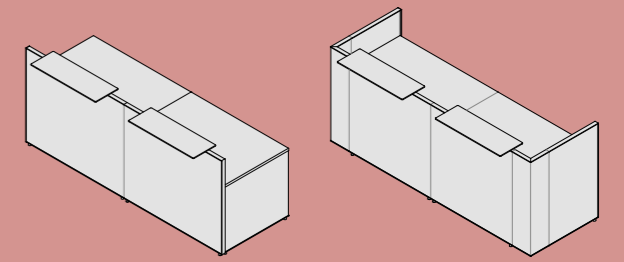

**OUTLINE**

*design:*  
Gianantonio Perin  
Monica Fernandes





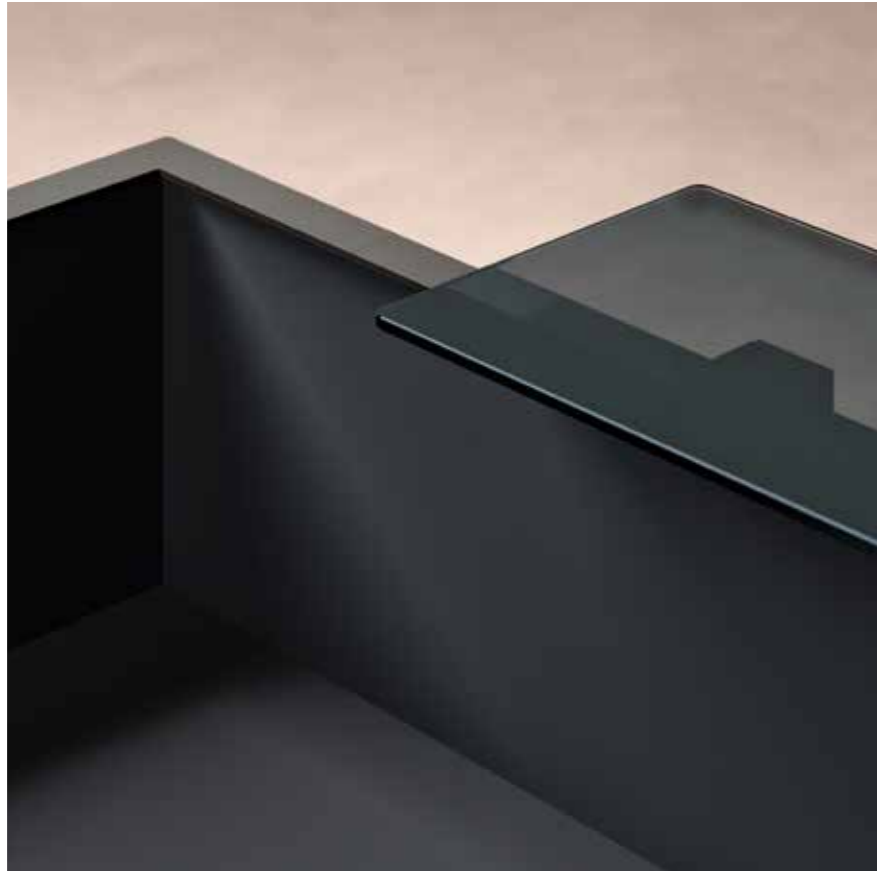













|  |  |  |   |
|--|--|--|---|
| <p><b>h</b> 102,3<br/><b>d</b> 82,7</p> <p><b>w</b> 81÷181</p>   | <p><b>h</b> 102,3<br/><b>d</b> 83,2</p> <p><b>w</b> 201÷361</p>  | <p><b>h</b> 102,3<br/><b>d</b> 83,2</p> <p><b>w</b> 125,4÷205,4</p>  | <p><b>h</b> 102,3<br/><b>d</b> 83,2</p> <p><b>w</b> 205,4÷405,4</p> |
| <p><b>h</b> 102,3<br/><b>d</b> 82,7</p> <p><b>w</b> 122,7÷202,7</p>  | <p><b>h</b> 102,3<br/><b>d</b> 62,7-82,7</p> <p><b>w</b> 163,2÷203,2</p>   | <p><b>h</b> 102,3<br/><b>d</b> 62,7-82,7</p> <p><b>w</b> 140,5÷180,5</p>   | <p><b>h</b> 102,3<br/><b>d</b> 60,5</p> <p><b>w</b> 4,1</p>         |
| <p><b>h</b> 102,3<br/><b>d</b> 82,7</p> <p><b>w</b> 80,5÷180,5</p>   | <p><b>h</b> 102,3<br/><b>d</b> 112,5-132,5</p> <p><b>w</b> 80÷120</p>  | <p><b>h</b> 71,8<br/><b>d</b> 17</p> <p><b>w</b> 80,5÷120,5</p>  | <p><b>h</b> 71,8<br/><b>d</b> 17</p> <p><b>w</b> 64,6</p>           |
| <p><b>h</b> 0,3<br/><b>d</b> 28</p> <p><b>w</b> 80-120</p> <p><b>metallo</b><br/>metal<br/>métal<br/>metal<br/>metal</p> | <p><b>h</b> 0,8<br/><b>d</b> 28</p> <p><b>w</b> 80-120</p> <p><b>vetro</b><br/>glass<br/>verre<br/>Glas<br/>vidrio</p> | <p><b>h</b> 1,8<br/><b>d</b> 28</p> <p><b>w</b> 80-120</p> <p><b>melaminico</b><br/>melamine<br/>mélamine<br/>melamin<br/>melamina</p> |   |

measure in cm • measurements in cm • mesures en cm • Maße in cm • medidas en cm

**profilo**  
profile  
profil  
Profil  
perfil

**gamba intermedia**  
middle leg  
piéd intermédiaire  
mittleres Bei  
pata intermedia

**metallo**, metal, métal  
metal, metal

**mensola**  
shelf  
étagère  
Regal  
repisa

**piedino**  
foot  
piéd  
Fuß  
pie

**piano e gamba**  
worktop and leg  
plateau et piètement  
Tischplatte und Wange  
tapa y pata

**melaminico**, melamine, mélamine,  
melamin, melamina

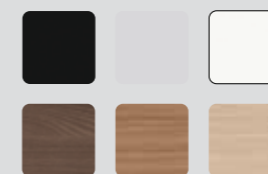

**profili e piedini**  
profiles and feet  
profils et pieds  
Rahmen und Füße  
perfiles y pies

**metallo**, metal, métal, metal, metal

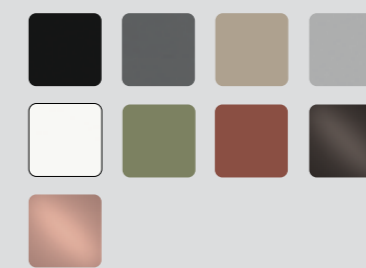

**frontali**  
fronts  
façade  
Fronten  
Frontal

**melaminico**, melamine, mélamine,  
melamin, melamina

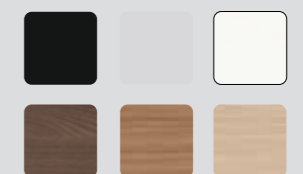

**frontali (solo esterno)**  
fronts (external only)  
façade (externe uniquement)  
Fronten (Nur extern)  
Frontal (solo externo)

**laccato opaco**, lacquered matt, lacqué mat,  
matt lackiert, lacado mate

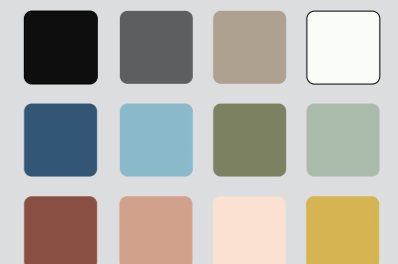

mensola • shelf • étagère • Regal • repisa

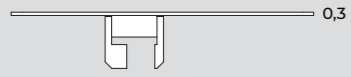

**metallo epox**  
metal epoxy  
epoxy métal  
epoxy metal  
epoxidico metal

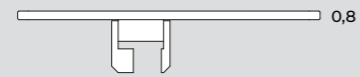

**vetro fumé**  
transparent smoke grey glass  
verre fumé  
rauchglas  
vidrio ahumado



**melaminico**  
melamine  
mélamine  
melamin  
melamina

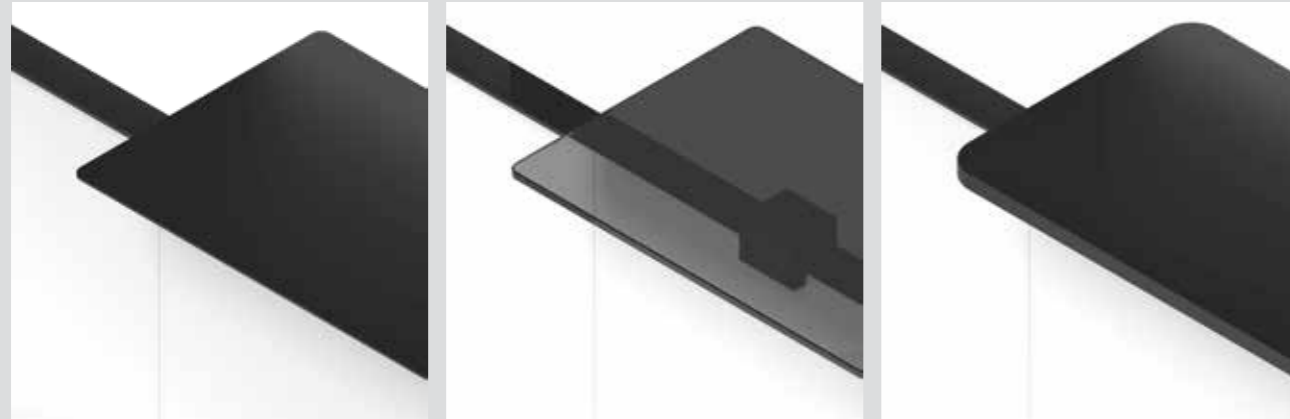

### highlights

**profilo**

profile  
profil  
Profil  
perfil

**piedino**

foot  
pied  
Fuß  
pie

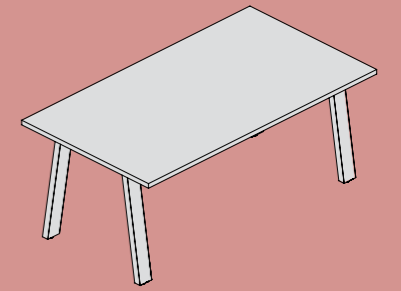

**FARM**

design:  
Gianantonio Perin













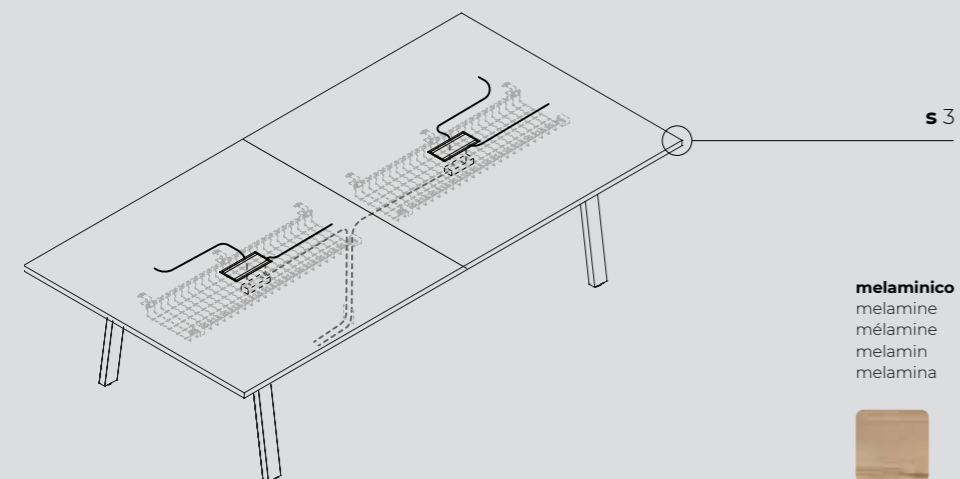
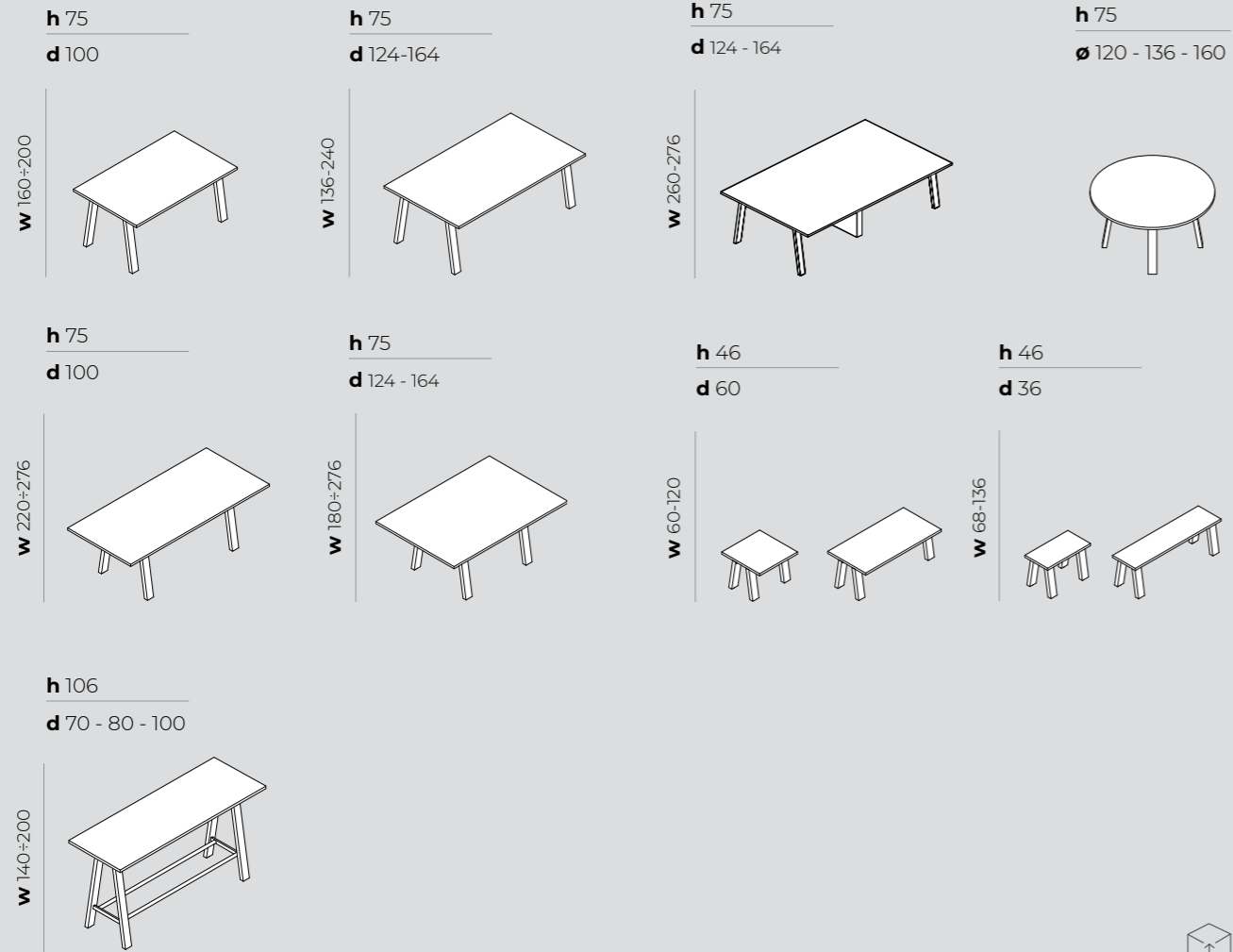

**melaminico**  
melamine  
mélamine  
melamin  
melamina

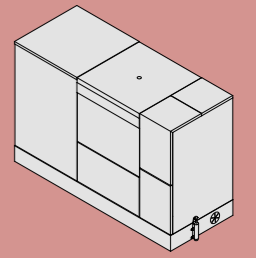

**DOMOMAG**

design:  
Francesco Fait





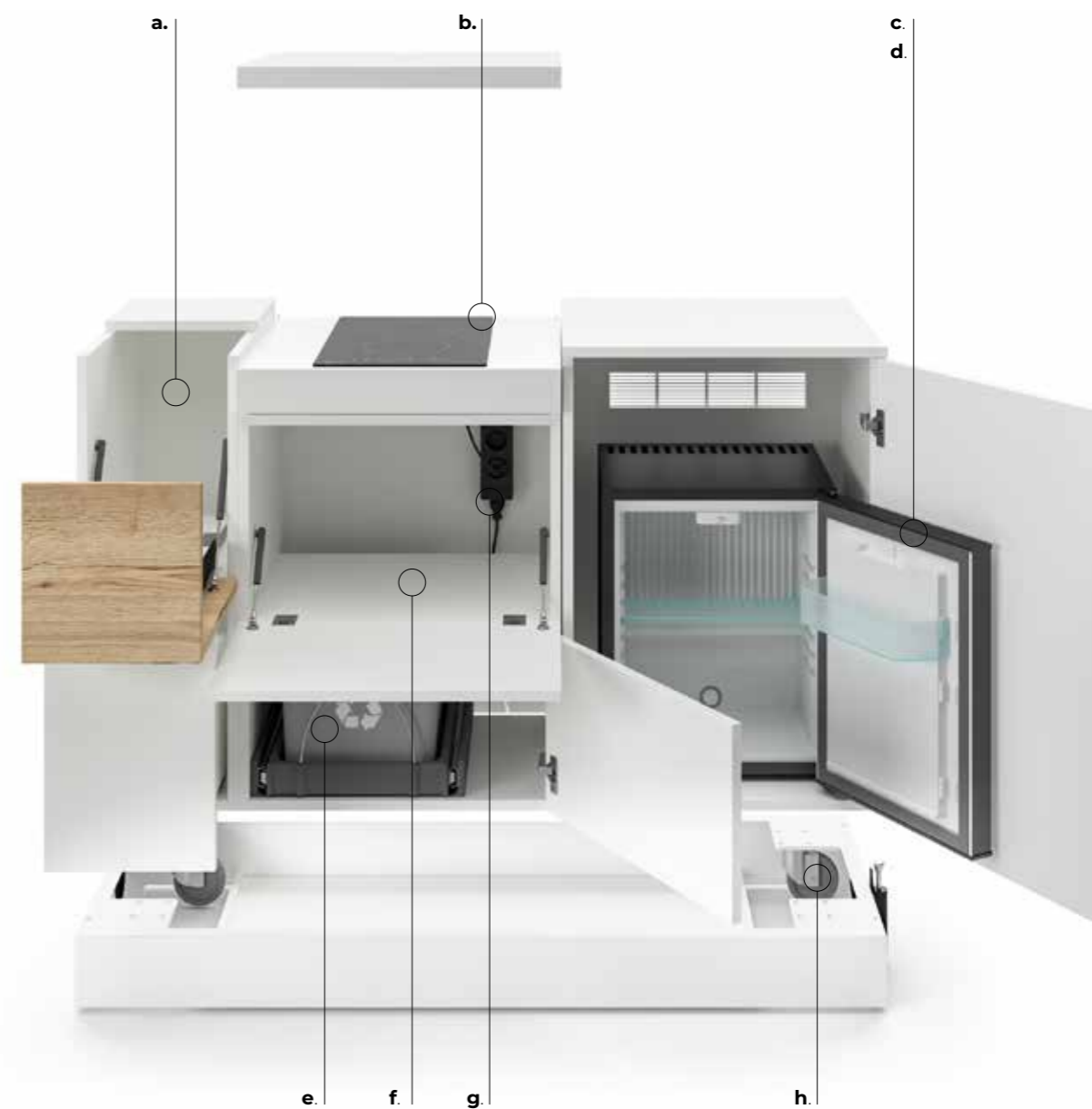
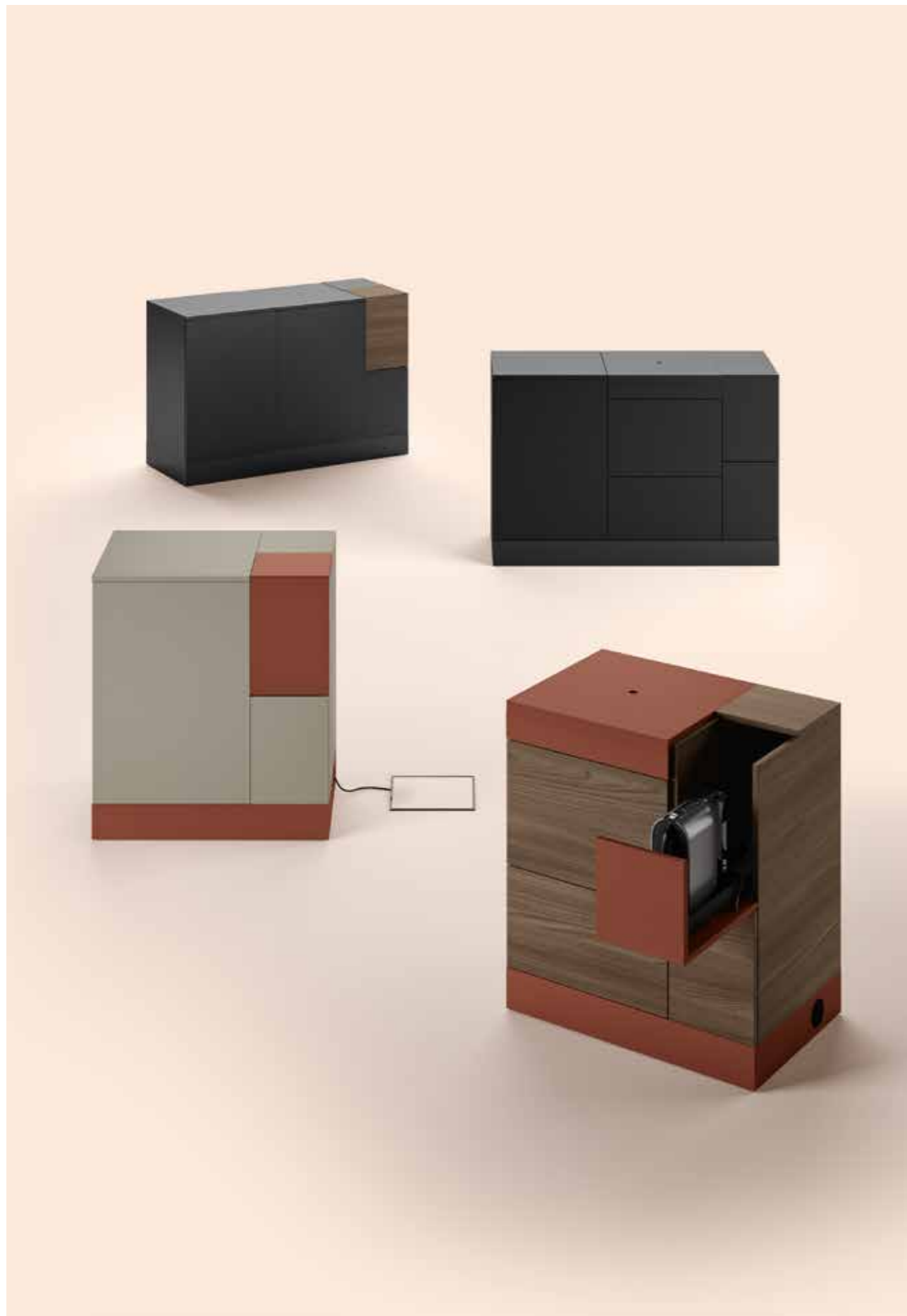

- |  |  |   |   |
|--|--|---|---|
| <p><b>a. vano macchinetta caffè</b><br/>coffee machine compartment<br/>module machine à café<br/>Kaffeemaschine Schrank<br/>compartimento cafetera</p> | <p><b>b. vano piano cottura</b><br/>hob compartment<br/>module de cuisson<br/>Kochfeld-modul<br/>compartimento de la placa</p>       | <p><b>c. vano frigorifero</b><br/>fridge compartment<br/>module réfrigérateur<br/>Kühlschrank Schrank<br/>compartimento frigorífico</p> | <p><b>d. vano dispensa</b><br/>pantry compartment<br/>module garde-manger<br/>Speisekammer Schrank<br/>compartimento despensa</p> |
| <p><b>e. vano porta rifiuti</b><br/>waste compartment<br/>module à déchets<br/>Abfallschrank<br/>compartimento de residuos</p>                         | <p><b>f. vano microonde</b><br/>microwave compartment<br/>module micro-ondes<br/>Mikrowelle Schrank<br/>compartimento microondas</p> | <p><b>g. elettrificabile</b><br/>Cable management opt<br/>module électrifié<br/>komplett elektrifiziert<br/>electrificable</p>          | <p><b>h. ruote</b><br/>castors<br/>roulettes<br/>Laufrollen<br/>ruedas</p>  |





- a. anta vano caffè**  
coffee machine  
compartment door  
porte du module à café  
Kaffeemaschine Schrank-Tuer
- b. vano piano cottura**  
hob compartment  
module de cuisson  
Kochfeld-modul  
compartimento de la placa
- c. lavandino**  
Kitchen sink  
module de lavage  
Waschbecken  
fregadero
- d. vano dispensa**  
pantry compartment  
module garde-manger  
Speisekammer Schrank  
compartimento despensa
- e. vano porta rifiuti**  
waste compartment  
module à déchets  
Abfallschrank  
compartimento de residuos
- f. vano microonde**  
microwave compartment  
module micro-ondes  
Mikrowelle Schrank  
compartimento microondas
- g. vano frigorifero**  
fridge compartment  
module réfrigérateur  
Kühlschrank Schrank  
compartimento frigorífico





**h** 92  
**d** 54

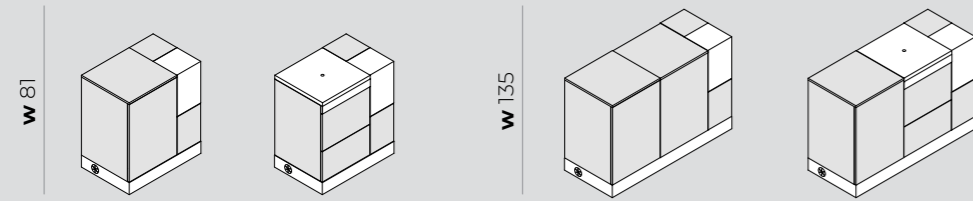

**h** 92  
**d** 54

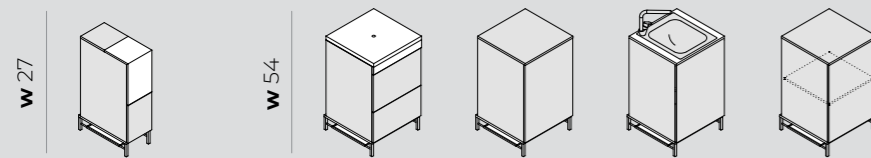

**h** 106  
**d** 54

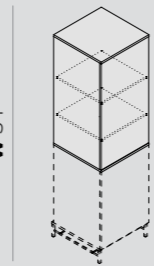

**h** 92  
**d** 54

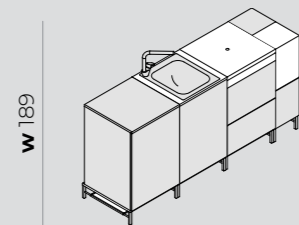
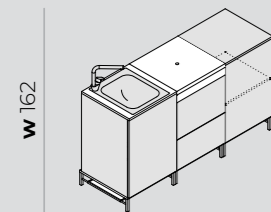

**h** 198  
**d** 54

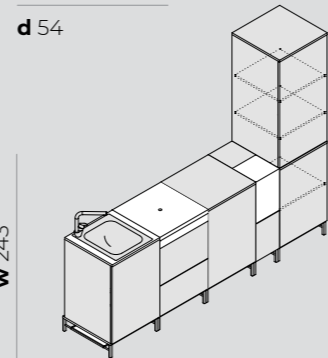

**moduli**  
modules  
modules  
module  
modulos

**anta vano caffè**  
coffee machine  
compartment door  
porte du module à café  
Kaffeemaschine Schrank-Tuer

**anta vano caffè**  
coffee machine  
compartment door  
porte du module à café  
Kaffeemaschine Schrank-Tuer

**struttura**  
structure  
structure  
Korpus  
estructura

**melaminico**, melamine, mélamine, melamin, melamina

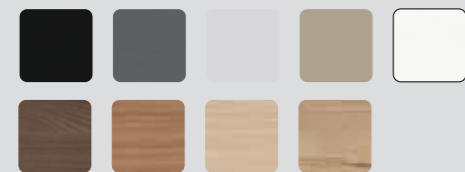

**laccato opaco**, lacquered matt, lacqué mat, matt lackiert, lacado mate

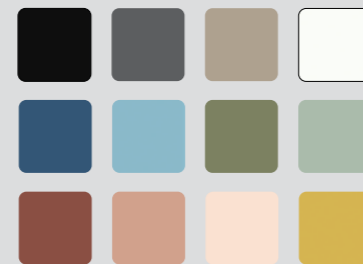

**metallo**, metal, métal, metal, metal

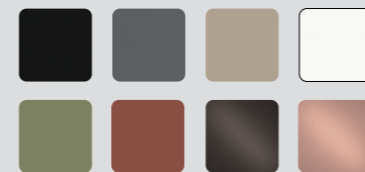

**misure in cm** • measurements in cm • mesures en cm • Maße in cm • medidas en cm

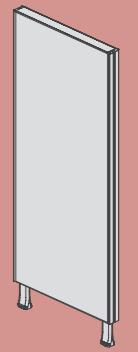

**KUBICK**

design:  
R&D Bralco









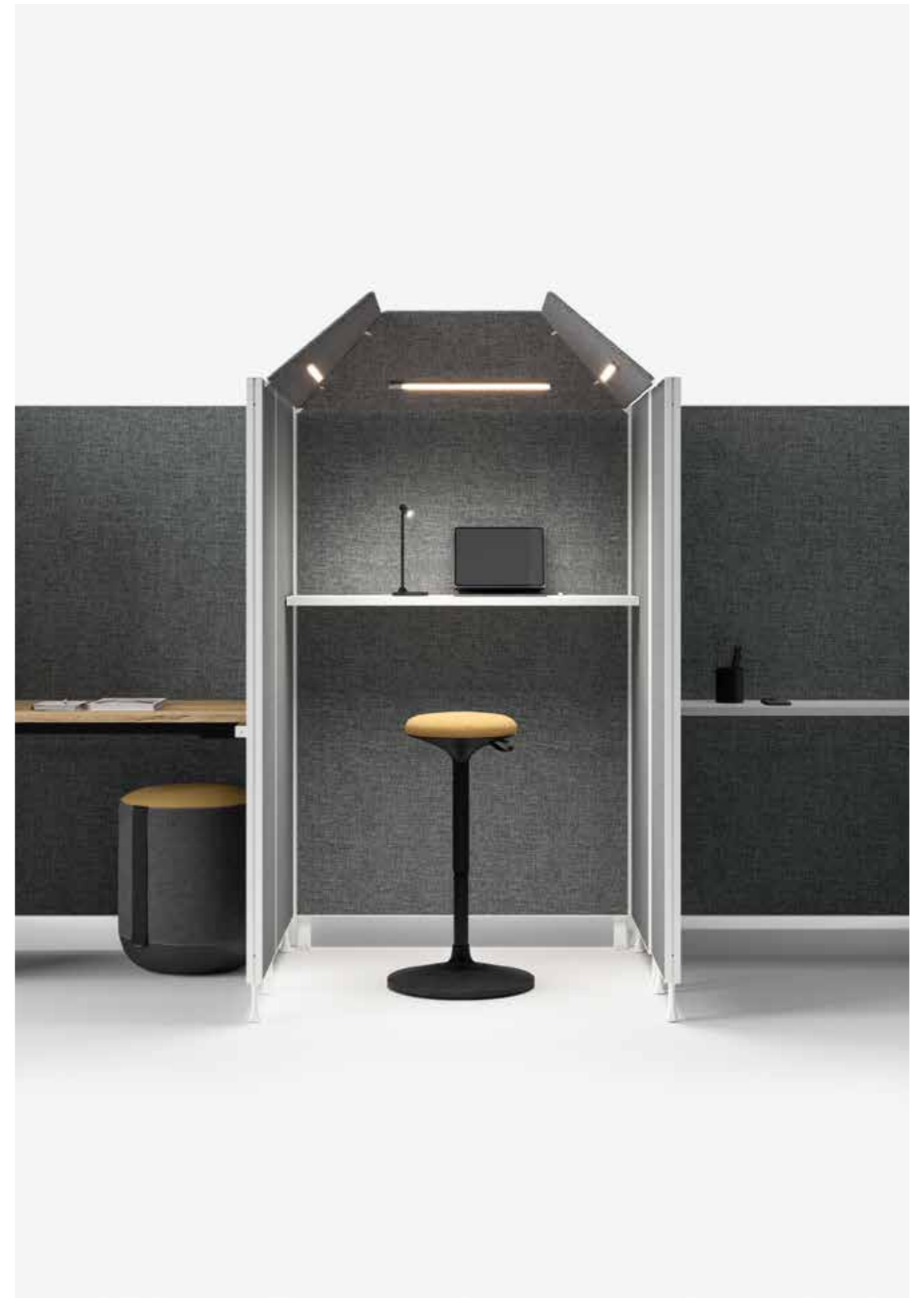



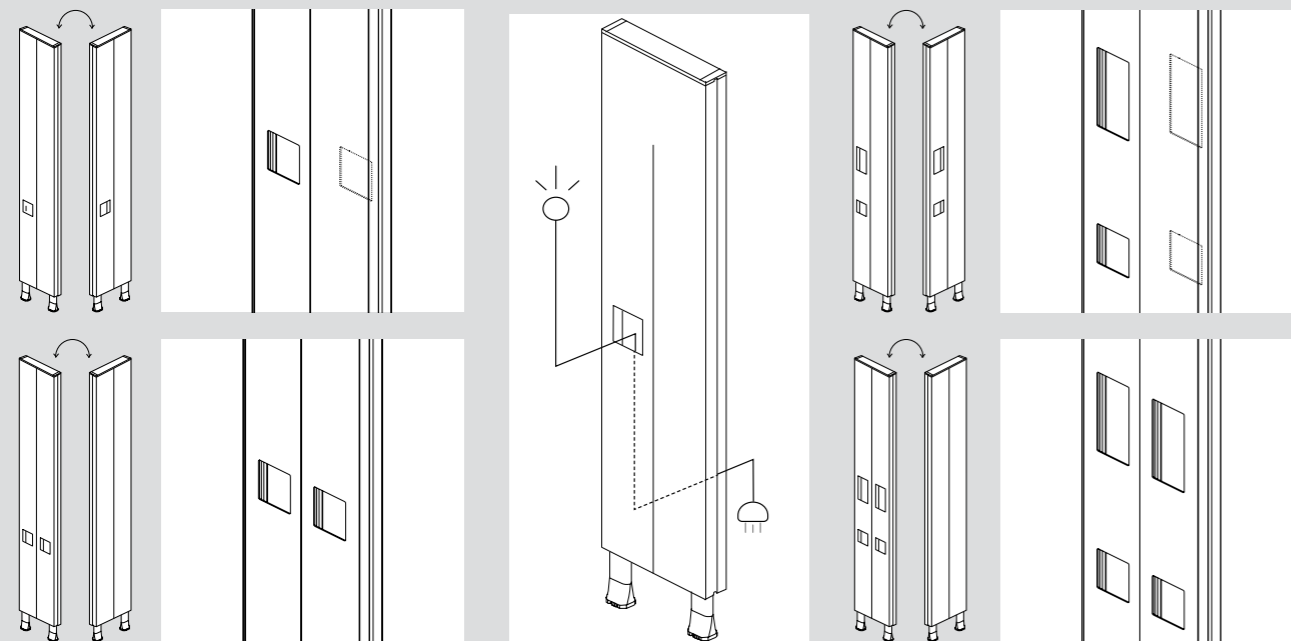
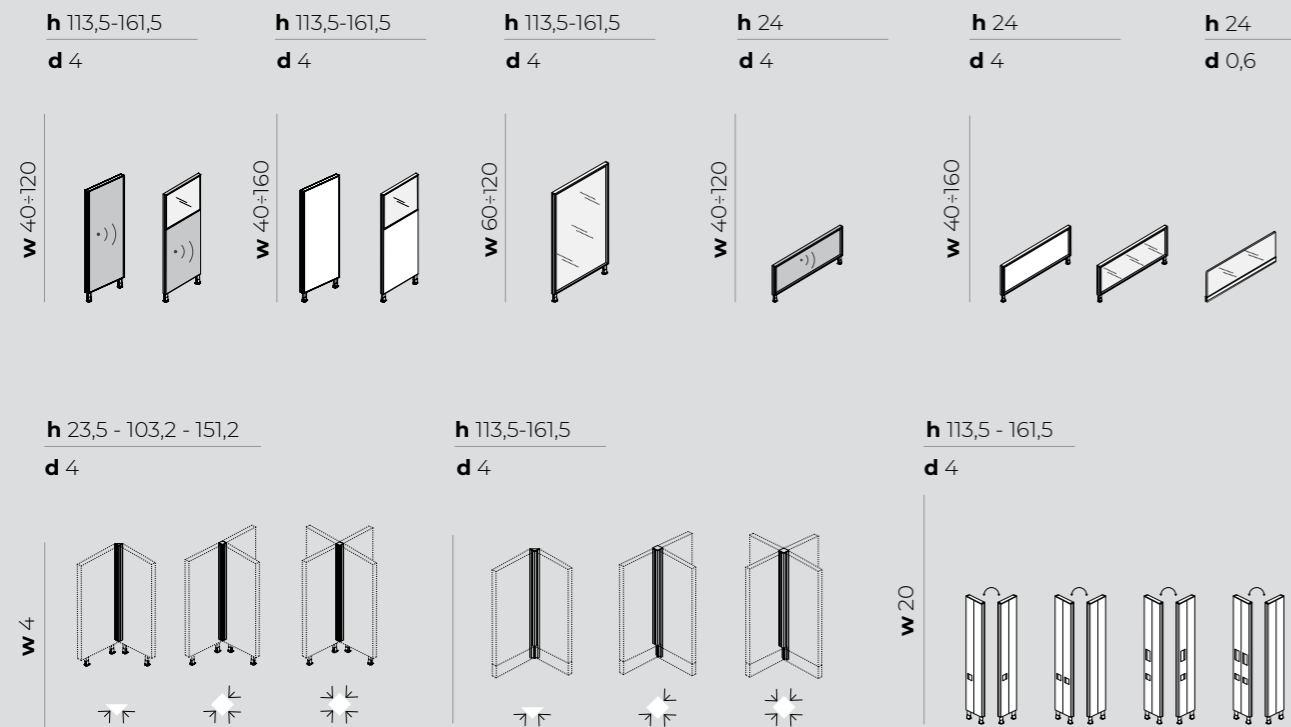

measure in cm • measurements in cm • mesures en cm • Maße in cm • medidas en cm

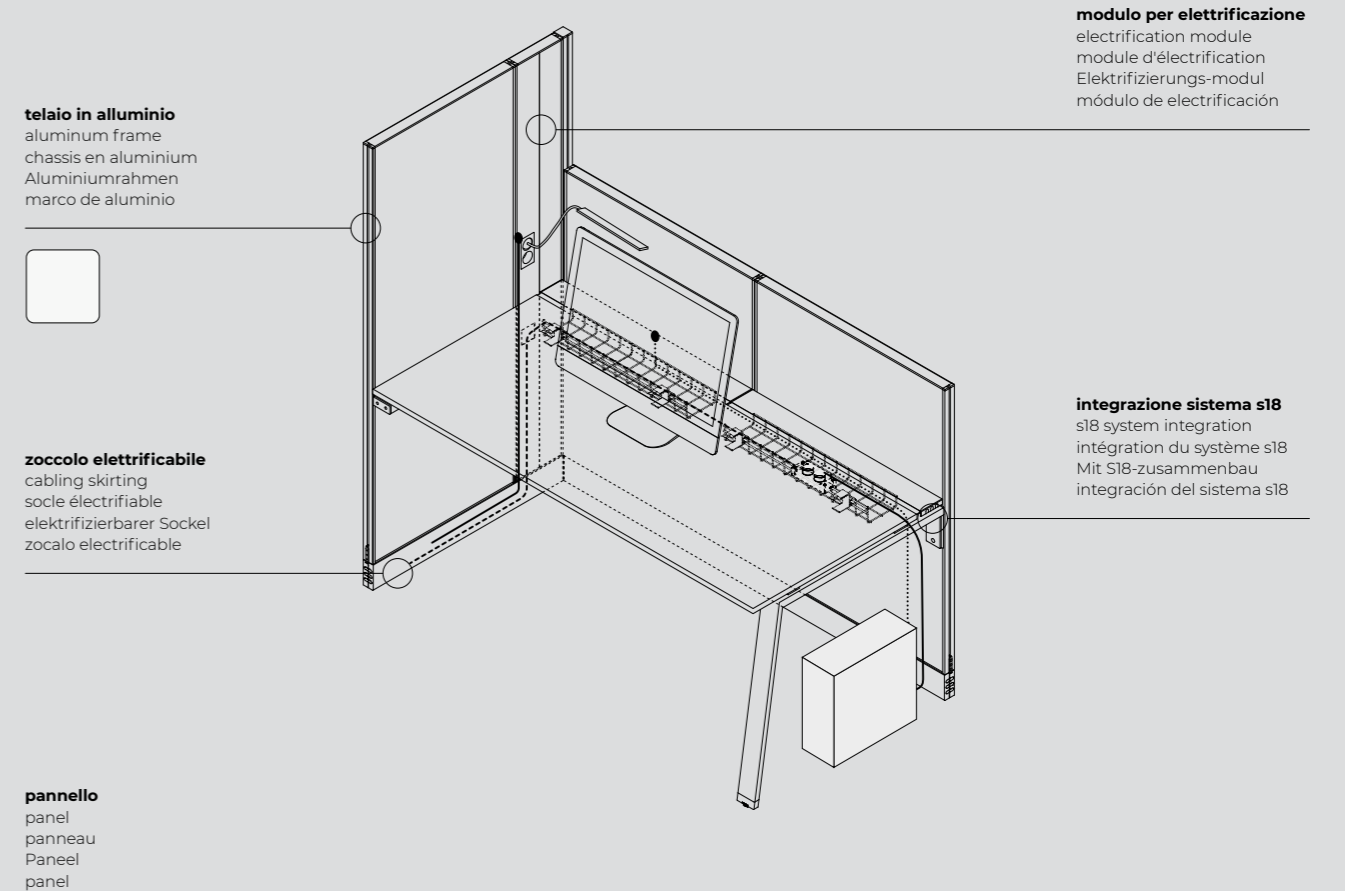

**melaminico**, melamine, mélamine, melamin, melamina



**vetro**, glass, verre, Glas, vidrio



**tessuto**, fabric, tissu, stoff, tejido





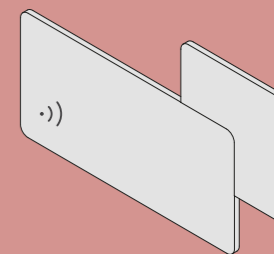

## **B-SOUND**

*design:  
gherardiarchitetti*

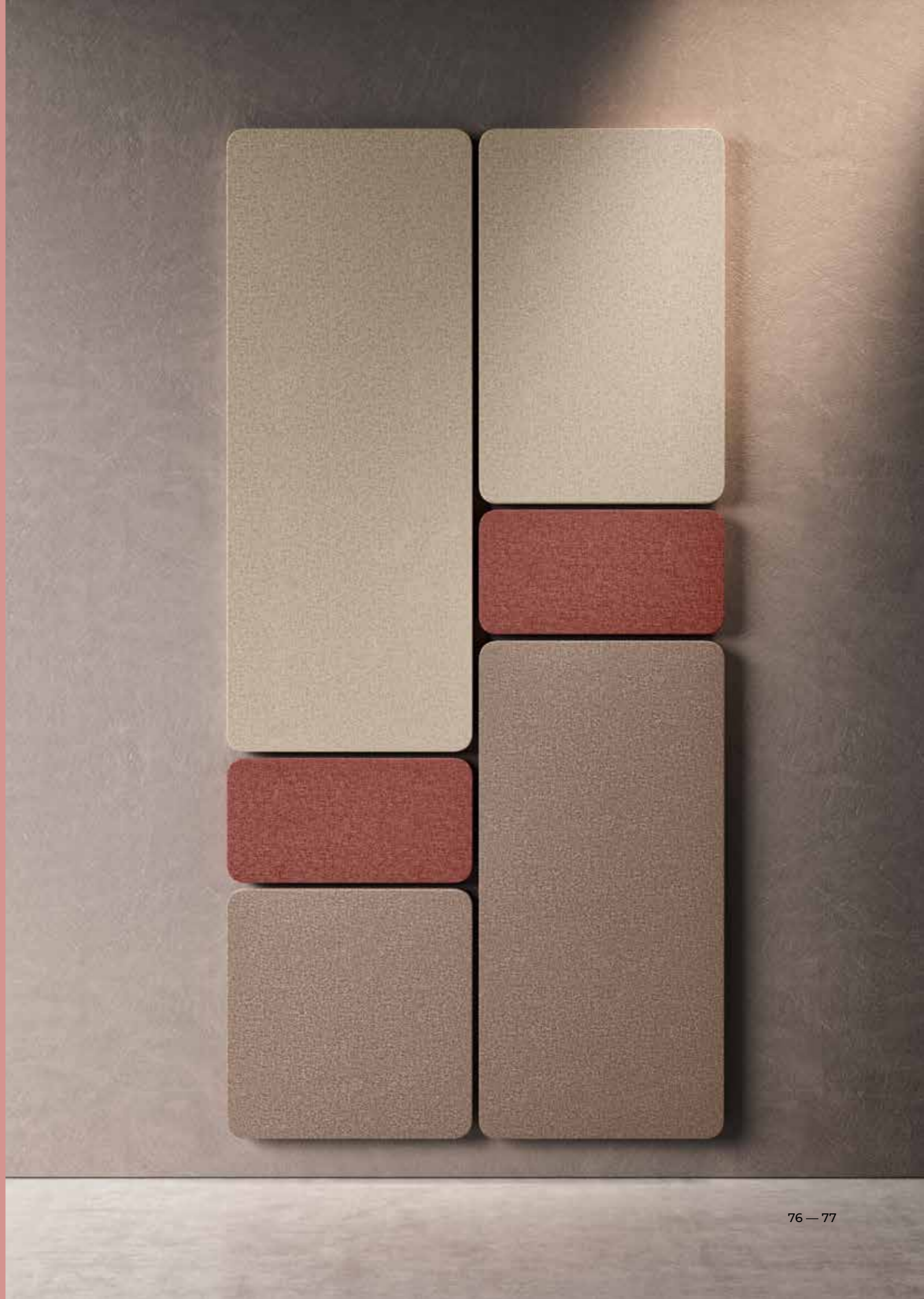





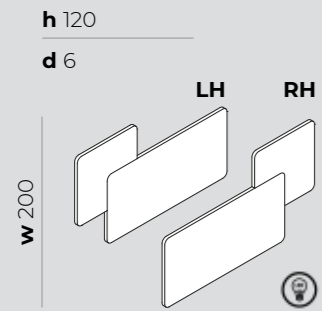
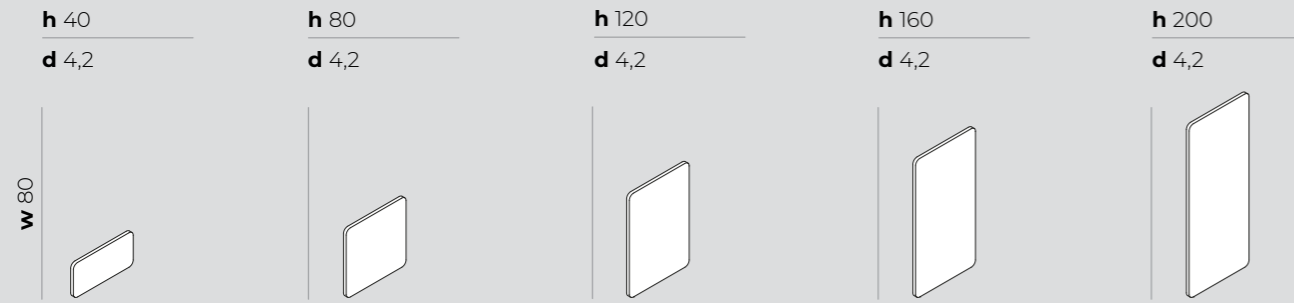

assorbimento acustico • acoustic absorption • absorption acoustique • Schallabsorption • absorción acústica

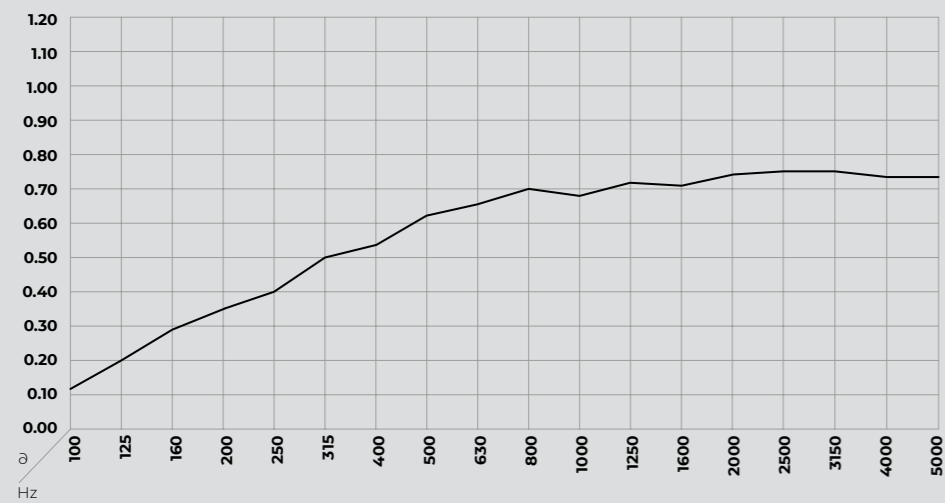

measure in cm • measurements in cm • mesures en cm • Maße in cm • medidas en cm



fissaggio tramite velcro  
velcro fastening  
fermeture par velcro  
Klettverschluss  
cierre con velcro

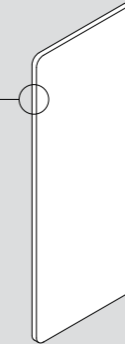

telaio perimetrale con led  
perimeter frame with LED  
chassis périmétrique avec LED  
Umfangrahmen mit LED  
marco perimetral con LED

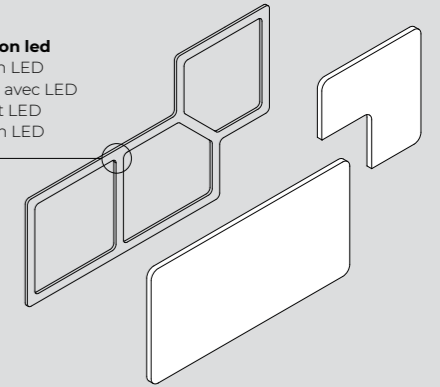

tessuto, fabric, tissu, stoff, tejido

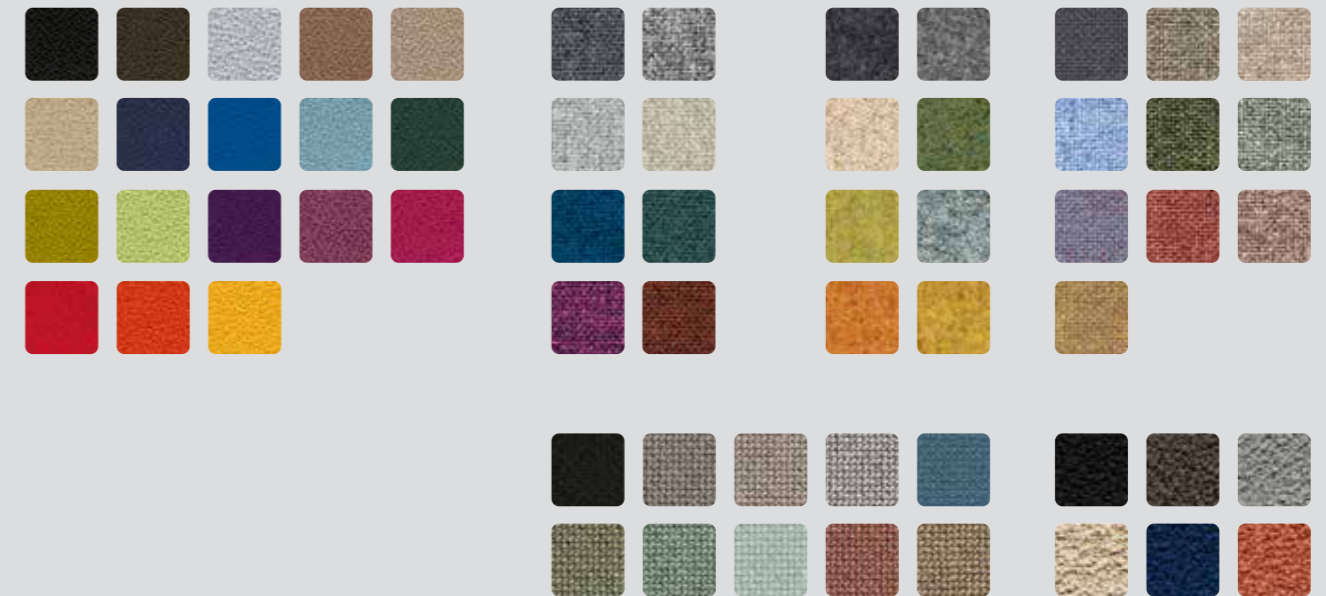

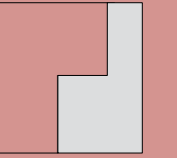

## COMPLEMENTI

complements  
compléments  
Ergänzungen  
complementos

*design:*  
*R&D Bralco*



FLIPPER







LOREN

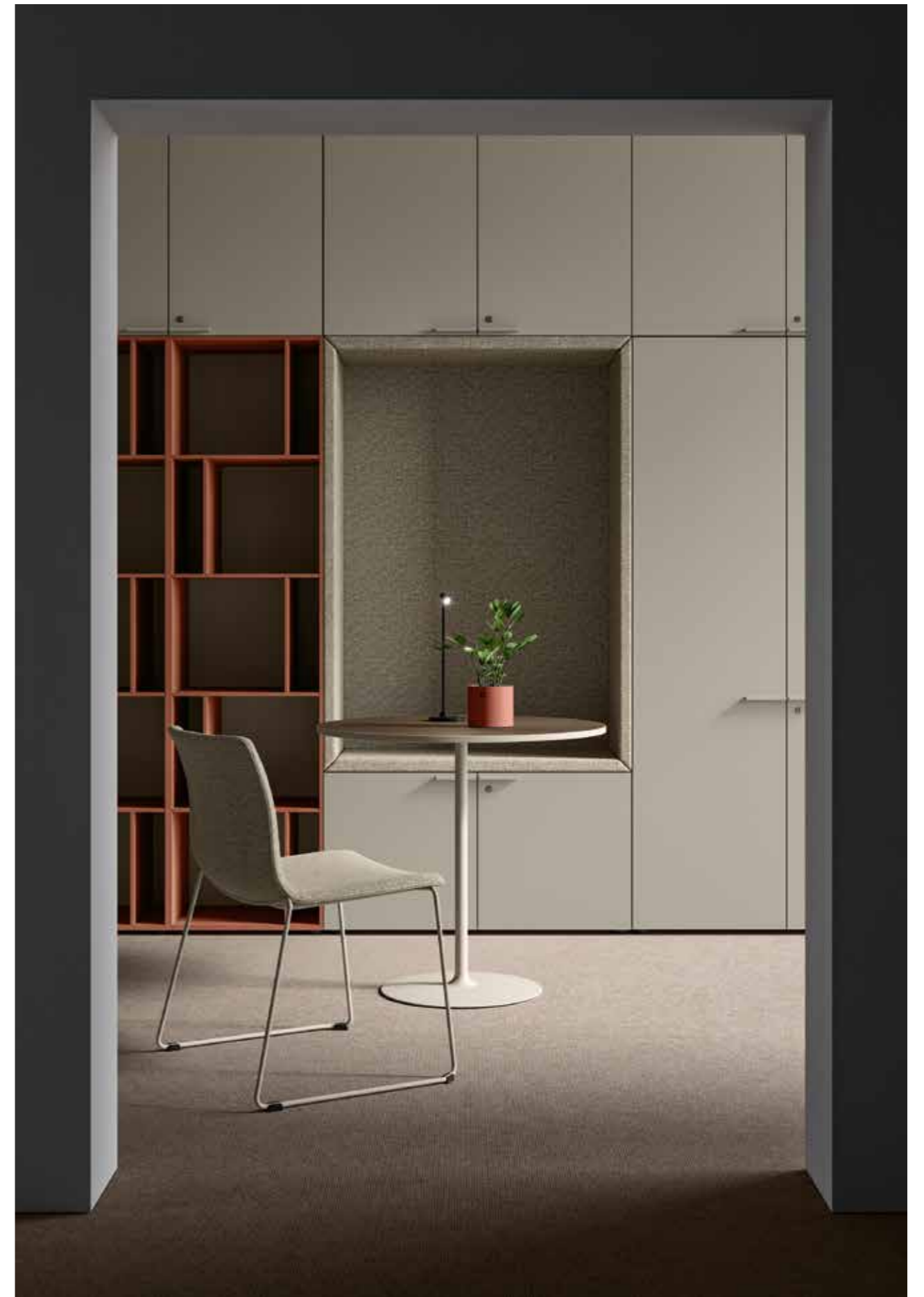



WINGLET



**TAVOLINO REGOLABILE IN ALTEZZA**

Height adjustable table  
Table réglable en hauteur  
Höhenverstellbarer Tisch  
Mesa regulable en altura



PICAKI

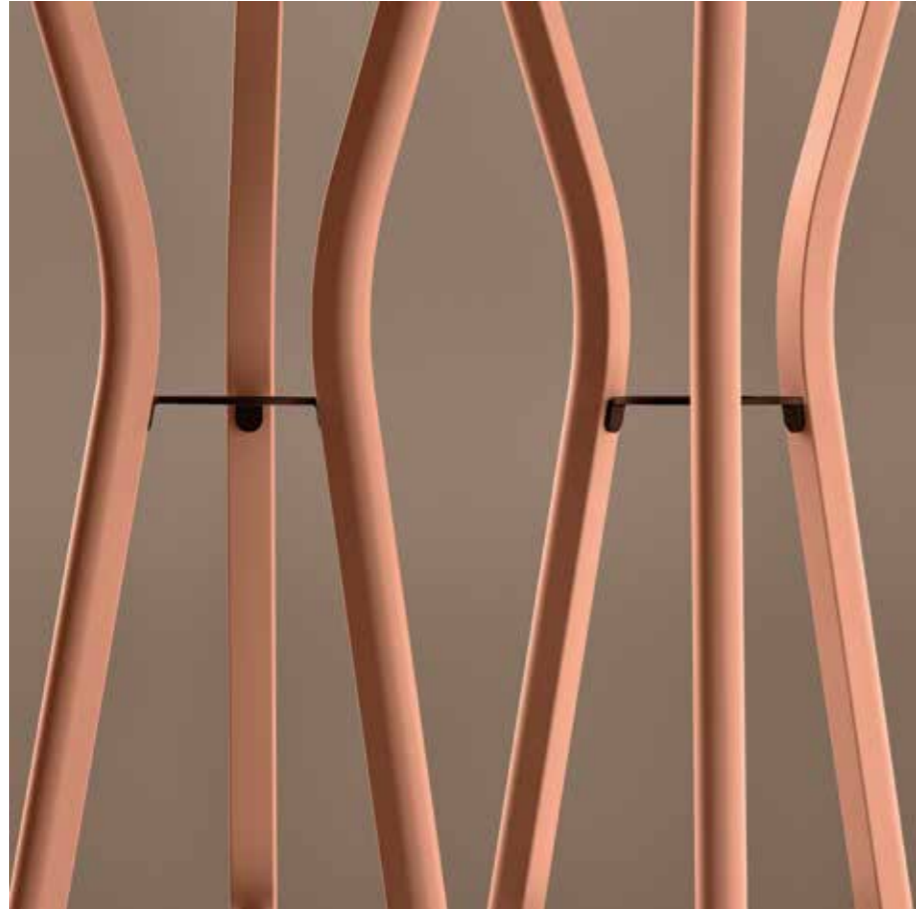



**FLIPPER**

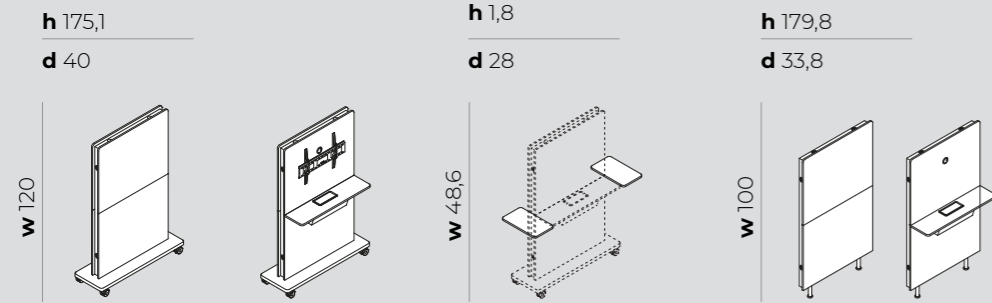

**struttura**  
frame  
structure  
Korpus  
estructura

**melaminico**, melamine, mélamine, melamin, melamina



**LOREN**

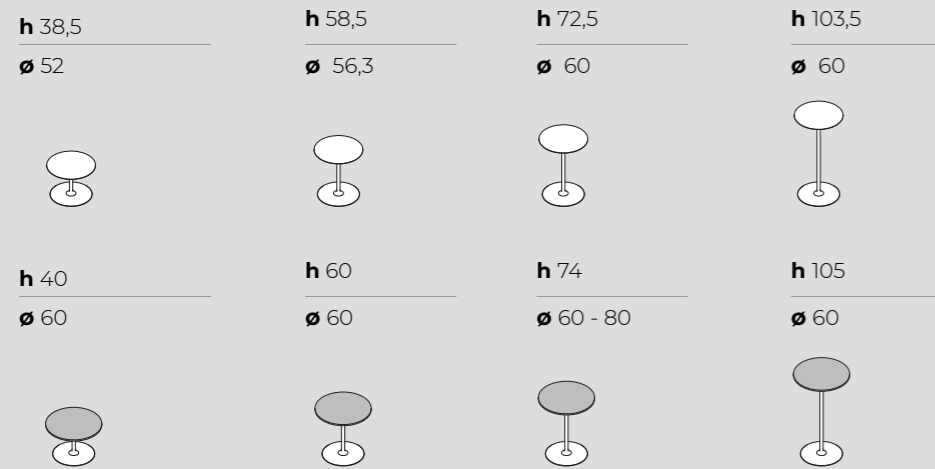

**struttura**  
frame  
structure  
Korpus  
estructura

**piano**  
top  
plan  
platte  
plano

**metallo**, metal, métal, metal, metal

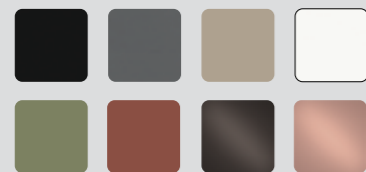

**melaminico**, melamine, mélamine, melamin, melamina



**metallo**, metal, métal, metal, metal

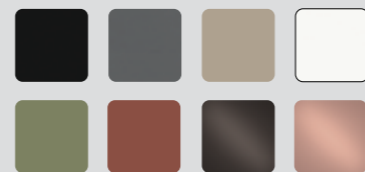

**misure in cm** • measurements in cm • mesures en cm • Maße in cm • medidas en cm

**WINGLET**

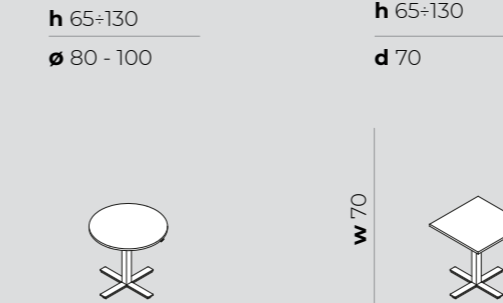

**highlights**

**batteria per sistema elevabile**  
battery for tables  
batterie pour tables  
Schreibtisch-Akku  
bateria para mesas



**struttura**  
frame  
structure  
Korpus  
estructura

**metallo**, metal, métal, metal, metal



**piano**  
top  
plan  
platte  
plano

**melaminico**, melamine, mélamine, melamin, melamina

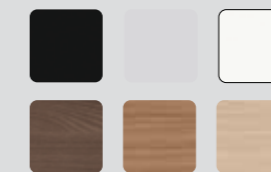

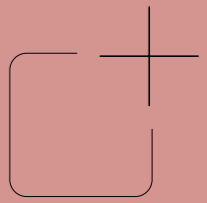

**BI**

**h** 52-70

**d** 37

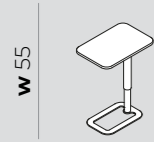

**struttura**  
frame  
structure  
Korpus  
estructura

**metallo**, metal, métal, metal, metal



**piano**  
top  
plan  
platte  
plano

**melaminico**, melamine, mélamine, melamin, melamina



**PICAKI**

**h** 160

**d** 45

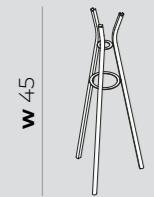

**legno**, veneer, bois, holz, madera



**laccato opaco**, lacquered matt, lacqué mat,  
matt lackiert, lacado mate

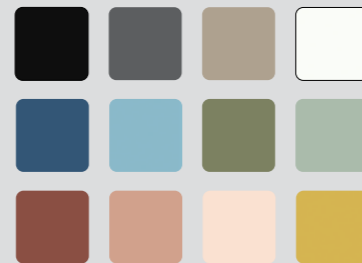

**misure in cm** • measurements in cm • mesures en cm • Maße in cm • medidas en cm

**ACCESSORI**

accessories  
accessories  
Zubehör  
accessorios

*design:*  
R&D Bralco





## ACCESSORI PER SCHERMI

screen accessories  
accessoires d'écran  
Bildschirmzubehör  
accesorios de pantalla





**PORTAPENNE**

Pen holder  
Porte-stylo  
Stifthalter  
Portalápices



**CESTINO / PORTAOMBRELLI**

Wastebasket/Umbrella stand  
Panier/Porte-parapluies  
Korb-/Schirmständer  
Cesta/Paraguas



**VASSOIO PORTA OGGETTI**

Storage tray  
Plateau de stockage  
Ablagefach  
Bandeja de almacenamiento

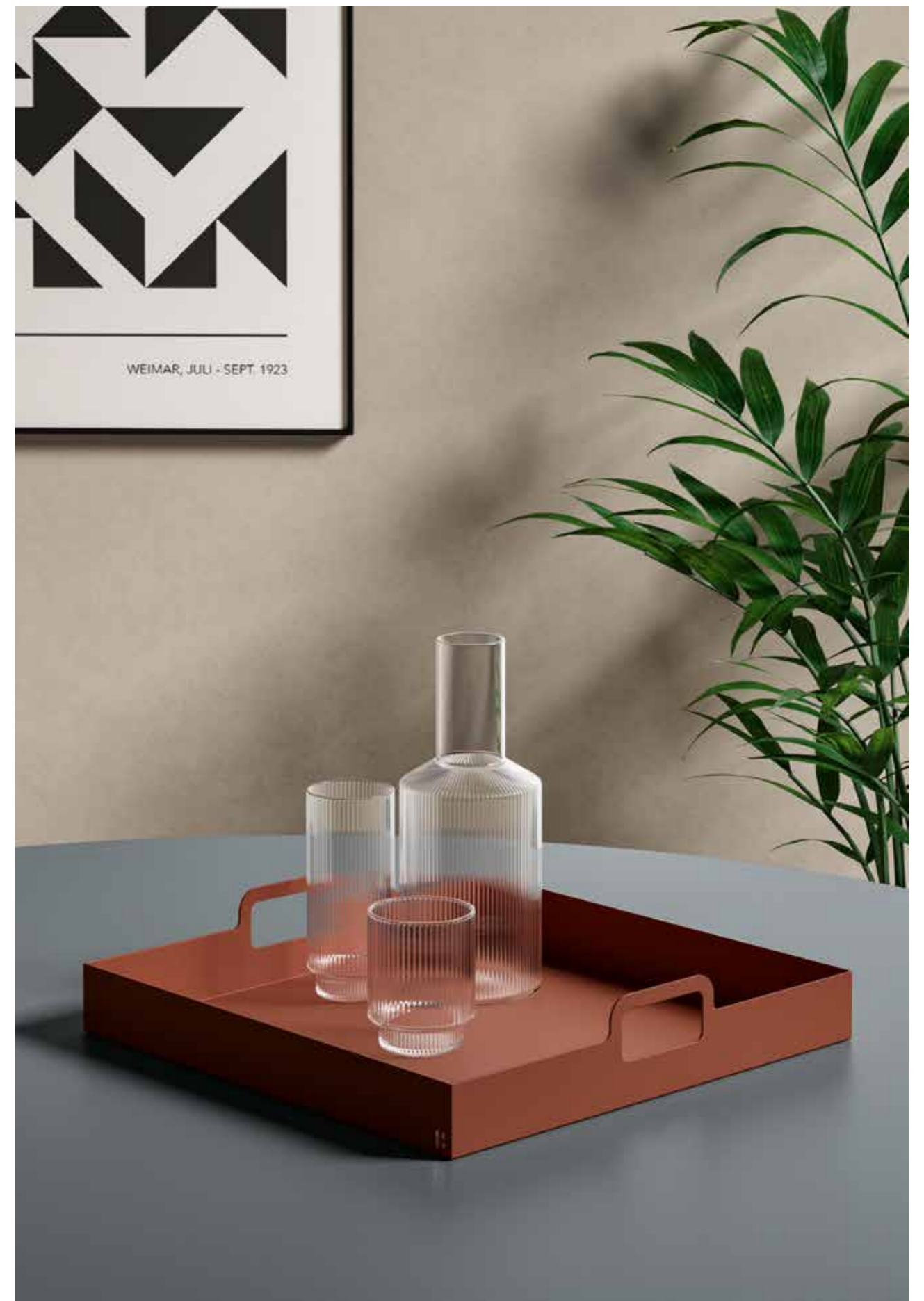
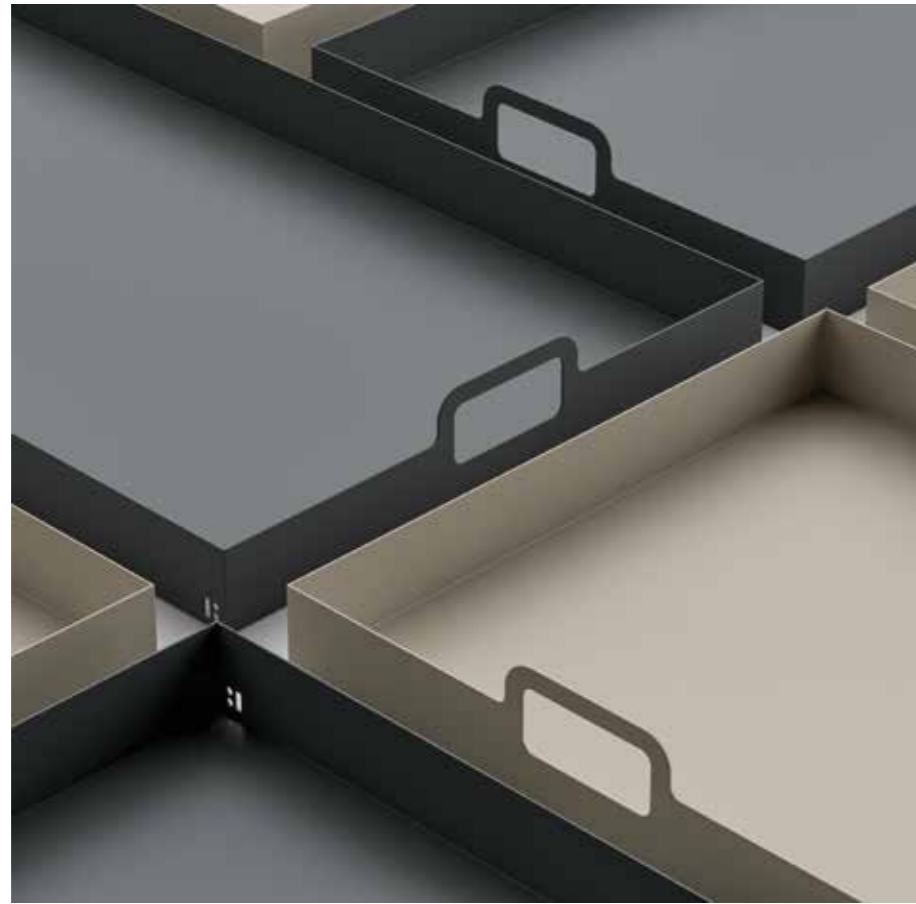

**REGGI LIBRI**

Bookends  
Ferme-livres  
Buchstützen  
Sujetalibros

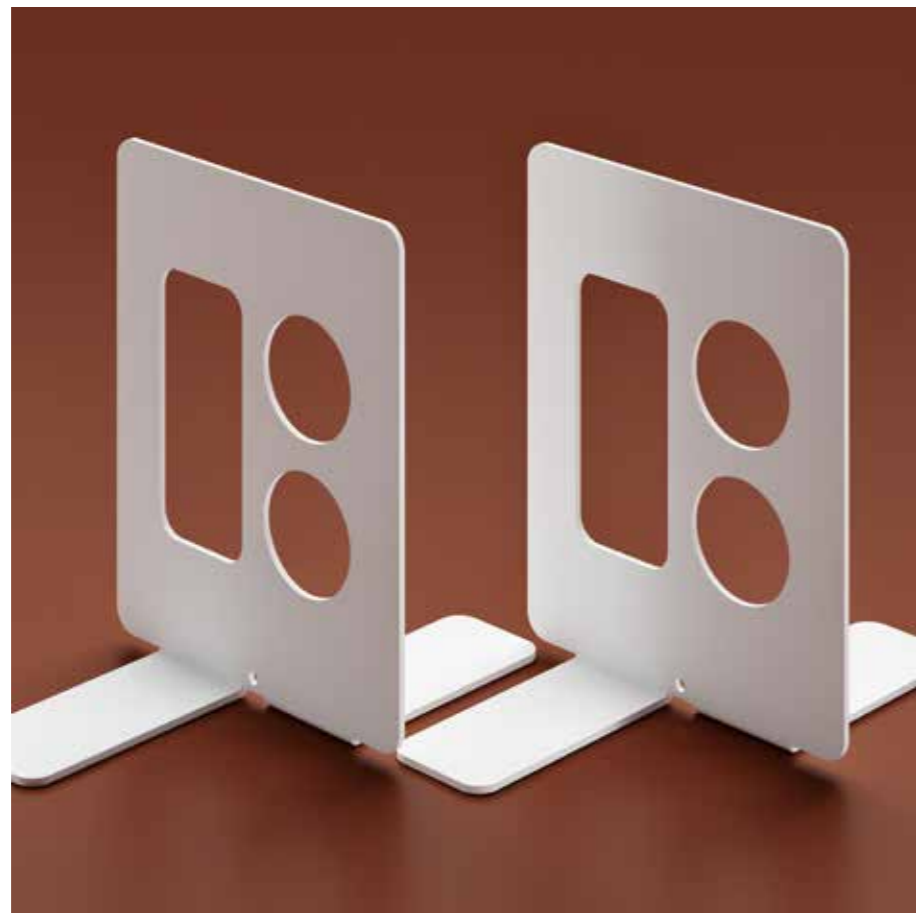

## GANCIO PORTABORSA

Bag hook  
Crochet pour sac  
Taschenhaken  
Gancho para bolso

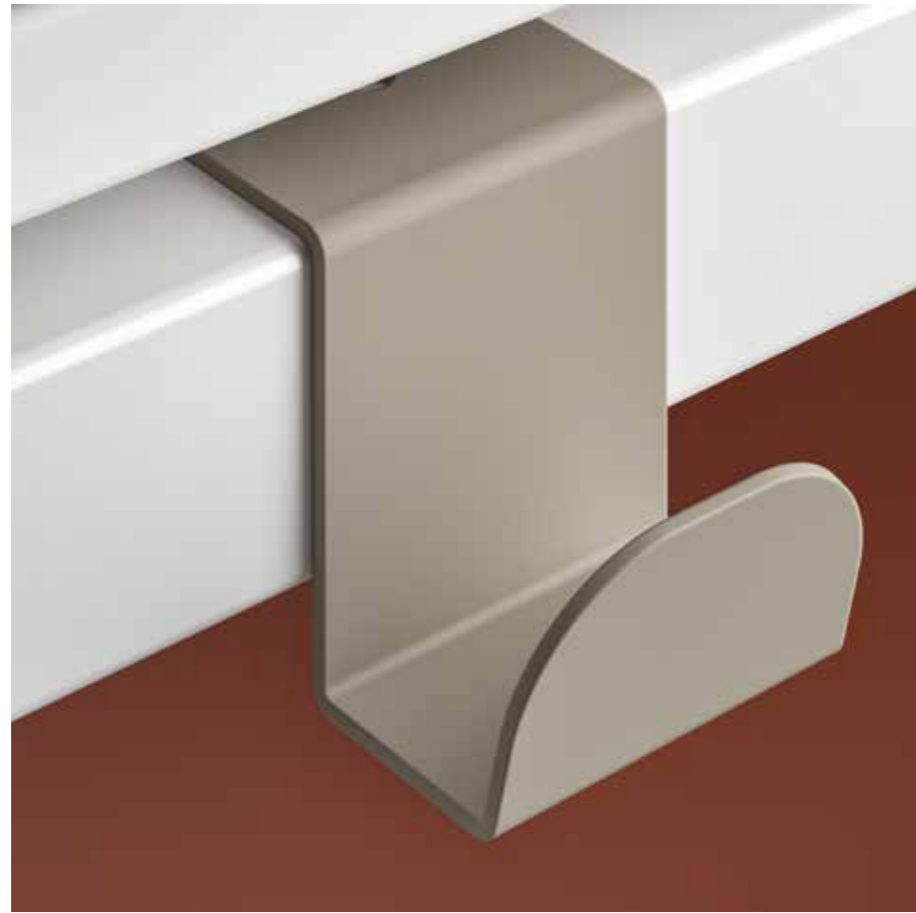



SPOT





**ACCESSORI PER SCHERMI** • screen accessories • accessoires d'écran • Bildschirmzubehör • accesorios de pantalla

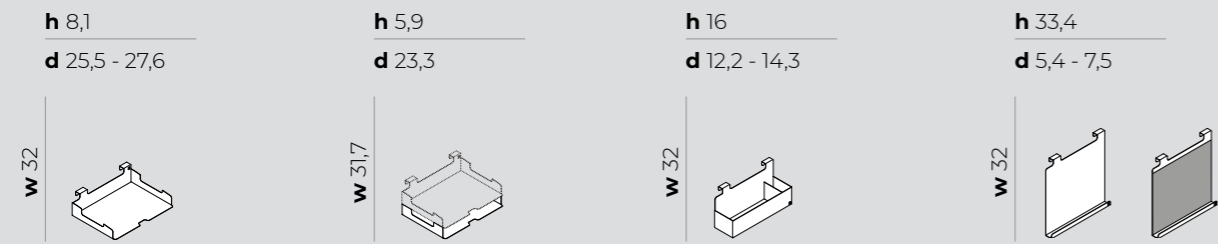

metallo, metal, métal, metal, metal



**PORTAPENNE** • pen holder • porte-stylo • Stifthalter • portalápices

**h** 10  
**Ø** 8



metallo, metal, métal, metal, metal



**CESTINO/PORTAOMBRELLI** • wastebasket/umbrella stand • panier/porte-parapluies • korb-/schirmständer • cesta/paraguas

**h** 40  
**Ø** 27,5



metallo, metal, métal, metal, metal



**VASSOIO PORTA OGGETTI** • storage tray • plateau de stockage • Ablagefach • bandeja de almacenamiento

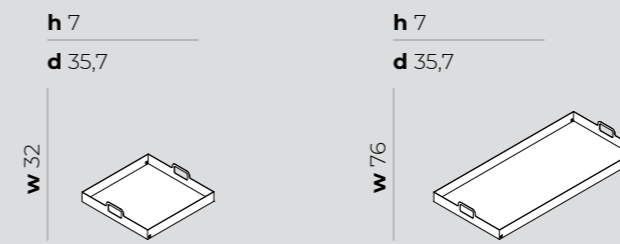

metallo, metal, métal, metal, metal



**REGGI LIBRI** • bookends • ferme-livres • Buchstützen • sujetalibros

**h** 20,6  
**d** 18

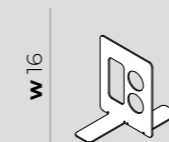

metallo, metal, métal, metal, metal



**GANCIO PORTABORSA** • bag hook • crochet pour sac • Taschenhaken • gancho para bolso

**h** 3  
**d** 5,4

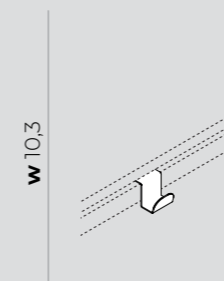

metallo, metal, métal, metal, metal

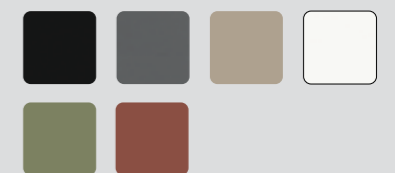



SPOT

h 26

∅ 10,5



h 89

∅ 16,5



metallo, metal, métal, metal, metal

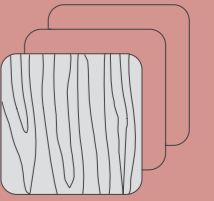

**FINITURE E COLORI**  
finishing and colors  
finitions et couleurs  
Oberfläche und farben  
acabados y colores



legno • veneer • bois • Holz • hout • maderá



**rovere laccato nero**  
black lacquered oak  
chêne laqué noir  
schwarz lackierter Eiche  
roble lacado negro

**rovere Carbon**  
Carbon oak  
chêne Carbon  
Eiche Carbon  
roble Carbon

**rovere tabacco**  
tobacco oak  
chêne tabac  
Eiche Tabak  
roble tabaco

**rovere grigio scuro**  
dark grey oak  
chêne gris foncé  
dunkelgraue Eiche  
roble gris oscuro



**rovere grigio**  
grey oak  
chêne gris  
Eiche grau  
roble gris

**rovere naturale**  
natural oak  
chêne naturel  
Natur Eiche  
roble natural

**rovere laccato bianco**  
white lacquered oak  
chêne laqué blanc  
weiß lackierter Eiche  
roble lacado blanco

melaminico • melamine • mélamine • melamin • melamina



**nero**  
black  
noir  
schwarz  
negro

**grigio titanio**  
titanium grey  
gris titane  
titangrau  
gris titanio

**grigio perla**  
pearl-grey  
gris perle  
perlgrau  
gris perla

**tortora**  
turtledove  
tourterelle  
taubengrau  
törtola

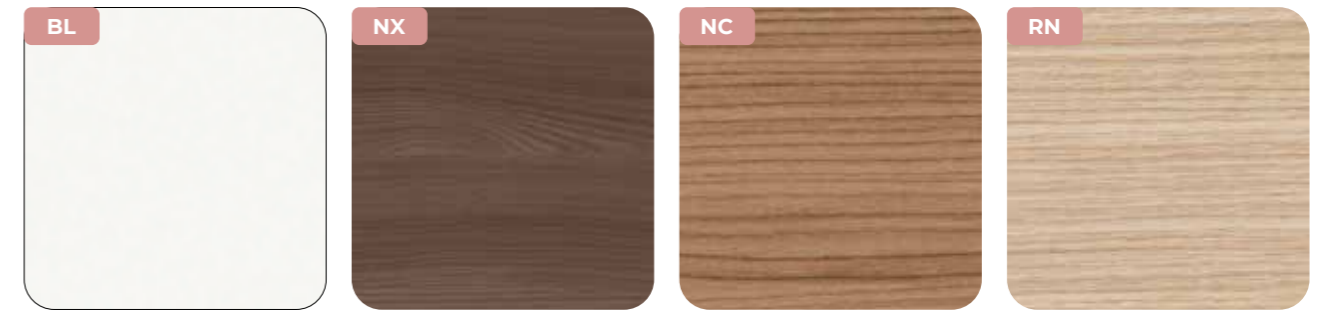

**bianco**  
white  
blanc  
weiß  
blanco

**noce Lux**  
walnut Lux  
noyer Lux  
lux Nussbaum  
nogal Lux

**noce canaletto**  
canaletto walnut  
noyer canaletto  
Canaletto Nussbaum  
nogal canaletto

**rovere naturale**  
natural oak  
chêne naturel  
Natur Eiche  
roble natural

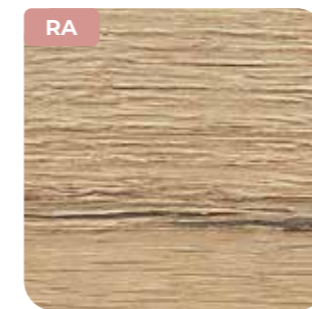

**rovere anticato**  
traditional oak  
chêne vieilli  
Eiche Antik  
roble antiguo

**RA**  
**Superficie antibatterica**  
Antibacterial surface  
Surface antibactérienne  
Antibakterielle Oberfläche  
Superficie antibacteriana



**metallo** • metal • métal • metall • metal

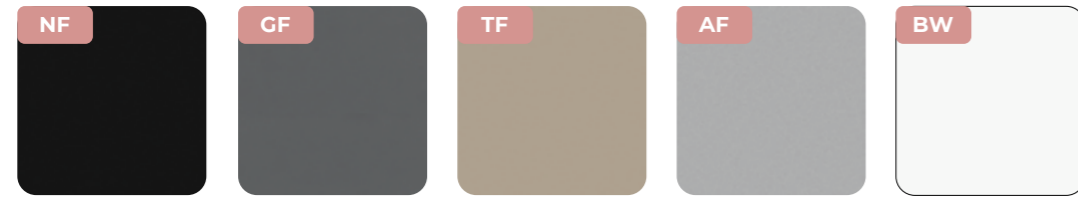

**nero**  
black  
noir  
schwarz  
negro

**grigio titanio**  
titanium grey  
gris titane  
titangrau  
gris titanio

**tortora**  
turtledove  
tourterelle  
taubengrau  
törtola

**epox alluminio**  
silver epoxy  
epoxy aluminium  
epoxy aluminium  
epoxidico alluminio

**bianco**  
white  
blanc  
weiß  
blanco



**oliva**  
olive  
olive  
olive  
oliva

**terracotta**  
terracotta  
terre cuite  
terracotta  
terracotta

**chromo lucido**  
glossy chrome  
chromé brillant  
Chrom poliert  
cromo brillo

**grigio ombra**  
shadow grey  
gris ombre  
vulcanschwarz  
sombra gris

**rame rosa**  
pink copper  
cuivre rose  
kupfer-Pink  
cobre rosa

**laccato opaco** • lacquered matt • laqué mat • matt lackiert • lacado mate

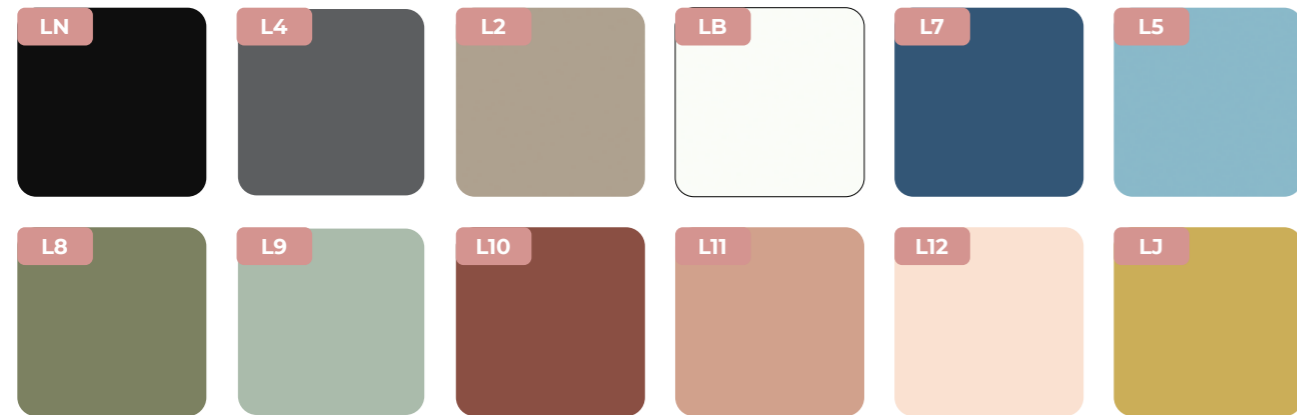

**vetro temperato** • tempered glass • verre trempé • sicherheitsglas • vidrio templado



**vetro stampato** • printed glass • verre imprimé • Bedrucktes Glas • vidrio impreso





tessuto • fabric • tissu • stoff • tejido

**MIRAGE**

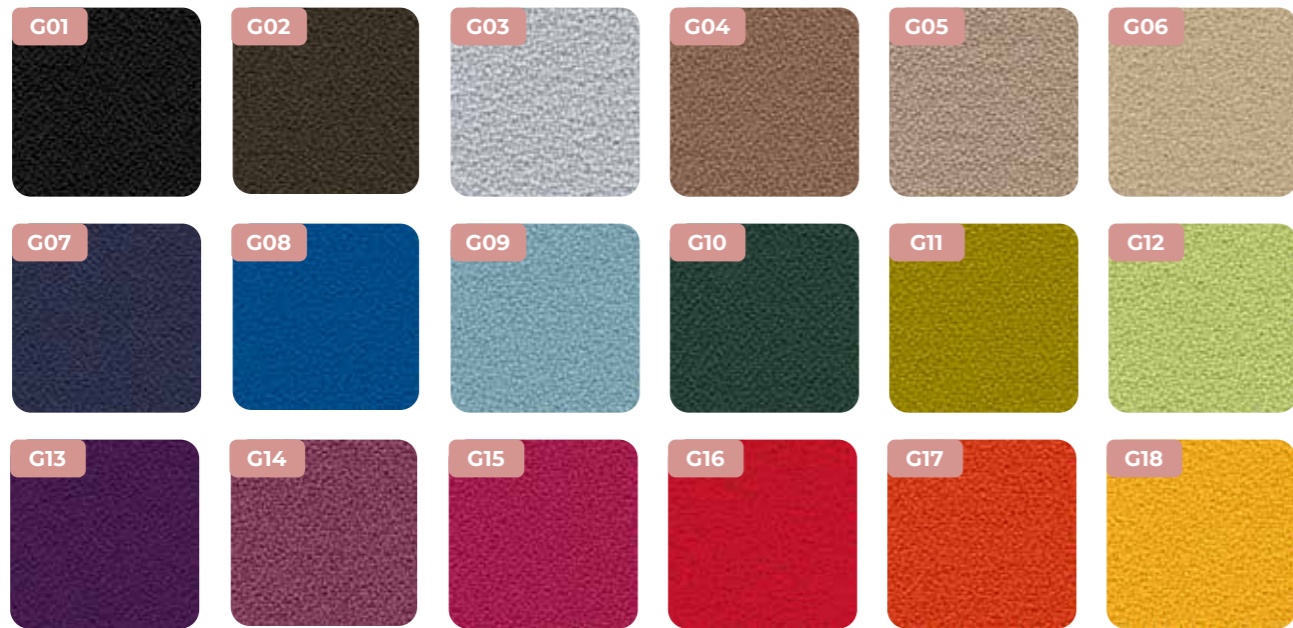

**NEMI MELANGE**



**FENICE**



**CONVERT MEL 4000**

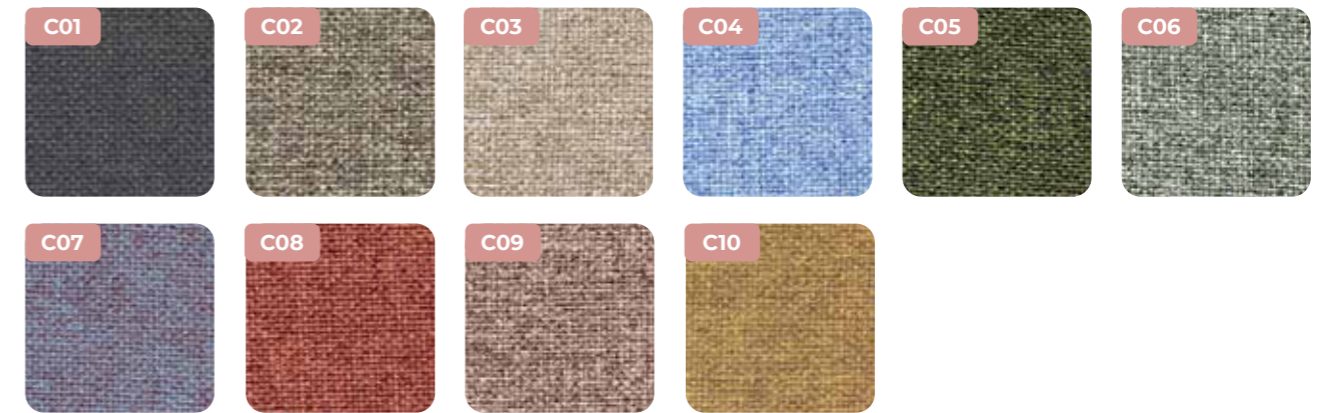

**CURA**



**POSEIDON**





**selezione delle materie prime** • selection of raw materials • sélection des matières premières • Auswahl der Rohstoffe • seleccion de materias primas

**attenzione e cura nella scelta dei materiali: Legno impiallacciato / vetro / pelle / tessuto / vetro ceramica** • attention and care in the selection of materials: veneer / glass / leather / fabric / vitro ceramic • attention et soin dans la sélection des matériaux: bois plaquage/verre/peau/tissu/vitro-céramique • Aufmerksamkeit und Sorgfalt bei der Auswahl der Materialien: Holzfurnier / Glas / Leder / Stoff / Glaskeramik • atención y cuidado en la selección de los materiales: madera pintada/vidrio/piel/tejido/vidrio ceramica



**produzione certificata, ecologica e rispettosa dell'ambiente e dell'utente** • certified production, green environmentally and user friendly • production certifiée, écologique et respectueuse de l'environnement et de l'individu • Zertifizierte, umweltfreundliche Produktion mit großer Respekt für Umwelt und Nutzer • Produccion certificada, ecologica y respetuosa del ambiente y del usuario



**progettazione** • space planning • projets • Projekte • proyectos



**capacità di produzione industriale** • industrial production ability • capacité de production industrielle • industrielle Produktionskapazität • capacidad de producción industrial



**garanzia e disponibilità dei componenti** • warranty and availability of components • garantie et disponibilité des composants • Garantie und Verfügbarkeit der Komponenten • garantía y disponibilidad de los componentes



**esperienza** • experience • expérience • Erfahrung • experiencia



**articoli speciali** • special items • articles spéciaux • Sonderanfertigungen • artículos especiales



**imballi costituiti da materiali facilmente separabili e riciclabili** • recyclable and easy to dispose packagings • emballages constitués de matériaux facilement séparables et recyclables • Die Verpackungen ermöglichen ein schnelles Trennen und Wiederverwertung von Materialien • embalaje constituido de materiales simplemente separables y reciclables



**riduzione di formaldeide e di sostanze tossiche e potenzialmente dannose** • low formaldehyde emission, low toxic and potentially harmful substances • réduction de formaldéhyde et des substances toxiques et potentiellement nocives • Reduzierung von Formaldehyd und Giftstoffe, die eine potentielle Gefahr darstellen • reducción de formaldehido y sustancias tóxicas y que pueden ser dañinas



**estensione del ciclo di vita dei prodotti** • product life extension • extension du cycle de vie du produit • Erweiterung der Produktlebensdauer • extension del ciclo de vida de los productos



**produzione di arredi a ridotto impatto ambientale** • furniture products with reduced environmental impact • production de mobiliers à impact environnemental réduit • Produktion von Einrichtungen mit niedriger Umweltbelastung • producción de mobiliario con reducido impacto ambiental



**facilità di disassemblaggio per favorire la riconfigurabilità, il riutilizzo o il riciclo** • easy reconfiguration, reuse or recycling • simplicité de démontage pour favoriser la reconfiguration, la réutilisation ou le recyclage • Leichte Zerlegung um Rekonfigurierbarkeit, Wiederverwendung oder Recycling zu ermöglichen • facilidad de desensamblaje para facilitar el configurar de nuevo, reutilizar y reciclar

**il nostro sistema di produzione segue standard avanzati per la cura dell'individuo e della natura** • our production system follows advanced standards for individual and nature care • notre système de production suit des standards avancées pour le soin de l'individu et de la nature • Unser Produktionsverfahren fortschrittlichen Standards für den Schutz von Mensch und Natur • nuestro sistema de producción sigue estandard avanzados para el cuidado al individuo y a la naturaleza.

**la nostra azienda opera con l'obiettivo primario di garantire prodotti che raggiungano un corretto equilibrio tra sostenibilità ambientale e design** • our Company operates with the primary objective of guaranteeing products that achieve a correct balance between, environmental sustainability and design • notre société a comme objectif principal celui de garantir des produits qui atteignent un juste équilibre entre, durabilité environnementale et design • Unsere Firma hat sich als Hauptziel die Garantie von Produkten gesetzt, welche ein korrektes Gleichgewicht zwischen Umweltverträglichkeit und Design erzielen • nuestra empresa trabaja con el objetivo primario de garantizar productos que alcanzan un correcto equilibrio entre sostenibilidad ambiental y de diseño

I nostri prodotti in melaminico possono essere forniti FSC® su richiesta cliente • Our melamine products can be FSC® supplied upon customer request • Nos produits en mélaminé peuvent être fournis certifiés FSC® sur demande du client • Unsere Melamin-Produkte können auf Anfrage des Kunden in FSC® geliefert werden • Nuestros productos de melamina pueden ser suministrados FSC® a petición del cliente



California 93120  
Compliant for Formaldehyde Phase 2



